

# 2022

User Manual



# Introduction to your Dash Cam

This range of Nextbase™ Dash Cams has been designed specifically with ease of use in mind; it is recommended NOT to change the default settings, which have been carefully selected to give the best performance for day to day use.

Please check the firmware version of the Dash Cam, the version can be found in the Setup menu under System Info.

The latest versions are available to download from our website, where you can download and update when necessary.

[www.nextbase.com](http://www.nextbase.com)

## Basic Operation

It is essential that a quality branded Class 10 or U1 type Micro SD card is used with this Dash Cam use to the very large data rate generated by high resolution recording. For best results, we recommend using our Nextbase™ branded SD cards with your Dash Cam.

Your Nextbase™ Dash Cam is set to record video, in files of just 1 minute in length. This means that each video file is a manageable size should you need to download and send to your insurance company. Eventually your MicroSD card will fill up with video files but don't worry, the camera automatically deletes the oldest file to make space for new recordings. This way you never run out of space and have plenty of driving data saved.

Typically a 16Gb card will store the last 1.5 hours of driving footage.

For summer months where the clocks are brought forward or for driving in other countries, adjust the time in the Setup Menu (Time & Date) to account for the time difference from GMT by adding or subtracting 1 hour as required.

There are 3 modes of camera operation - Video, Photo and Playback.

Press the MODE button on the Dash Cam to select required mode.

Video Mode: The default mode when the camera is turned on, for video recording.

Photo Mode: Allows you to take still photographs.

Playback Mode: Allows you to view recorded video or photographs upon the Dash Cam LCD screen.

## Automatic Start / Stop Technology

The Dash Cam will automatically power on and be ready to use once power is available.

In some vehicles this will be when connections are made, for others the Dash Cam will power on once the ignition has been turned on. When power is cut off, the Dash Cam will perform an automatic shutdown process.

## 1. Tips for capturing best video footage:

- 1.1 Position the Dash Cam in the centre of the windscreen and ideally behind the rear view mirror so it is not a distraction to the driver.
- 1.2 Ensure that the area on the windscreen that the Dash Cam is looking through is clear of dirt and is within the wiper zone. This will ensure that your videos are as clear as possible.
- 1.3 Reduce the amount of sky in the picture, by angling the view of the camera towards the road. Too much sky will make the road appear darker due to the automatic exposure compensation.
- 1.4 Remove unnecessary items from your dashboard. If objects are placed on your dashboard these can cause reflections to be seen on the windscreen and these reflections may be captured during recording.
- 1.5 To improve dash board glare, a Nextbase™ Polarising Filter can be purchased.

## 2. Tips for stable memory card performance:

- 2.1 Periodically format the memory card. Every 2-3 weeks we recommend that you format the memory card. This will wipe any files from the card and set it up afresh for continued use with your Dash Cam. Of course, you should only do this AFTER you've downloaded any files from the card that you may want to keep, as formatting the card will remove all content.
- 2.2 Format your memory card using the Dash Cam. This will make sure that the card is structured specifically for your camera. Press MENU twice and choose the Format Card option. Follow the on-screen instructions accordingly.
- 2.3 Switch off the Dash Cam before removing the SD memory card, to prevent the chance of damage being caused to the memory card or the files stored upon it.

# Table of Contents

INTRODUCTION TO USING YOUR DASH CAM	02	VIDEO MODE / PHOTO MODE / PLAYBACK MODE	23
TABLE OF CONTENTS	03	PLAYBACK MODE MENUS - PROTECT & DELETE FUNCTIONS	24
PRECAUTIONS / CAUTIONS ON USING THIS PRODUCT	04	MYNEXTBASE PLAYER™	25
PRODUCT WARNINGS	05	MYNEXTBASE PLAYER™ - EDITING	26
USAGE PRECAUTIONS / NOTICES / CANADA COMPLIANCE	06	MYNEXTBASE CLOUD™	27
CE DECLARATION OF CONFORMITY / FCC STATEMENT	07	PC CONNECTION / FIRMWARE UPDATE INFORMATION	28
FCC- SUPPLIER'S DECLARATION OF CONFORMITY	08	NEXTBASE™ SD CARDS	29
PRODUCT SPECIFICATION	09	FREQUENTLY ASKED QUESTIONS (PAGE 1)	30
PACKAGE CONTENTS / PRODUCT FEATURES	10	FREQUENTLY ASKED QUESTIONS (PAGE 2)	31
CAMERA PARTS & CONTROLS	11	CE MARK INFORMATION / SOFTWARE LICENSE AGREEMENT	32
CAMERA PARTS & CONTROLS (CONT.)	12	WARRANTY / ONLINE & INTERNATIONAL PURCHASES	33
IN VEHICLE INSTALLATION	13 - 16	MORE NEXTBASE™ PRODUCTS	34
POSITIONING YOUR DASH CAM / ACCESSORIES	17	DASH CAM FUNCTIONS	35
CHANGING MOUNTS	18		
FIRST TIME USE	19		
MENU / VIDEO MENU OPTIONS	20		
MENU / SETUP MENU OPTIONS	21		
SETUP MENU OPTIONS	22		

## Precautions

Please read this manual carefully before operation and keep it for future reference. It will be helpful should you encounter any operational problem.

**WARNING:** Do not expose this product to rain, moisture or water under any circumstances, doing so may result in the risk of electric shock or fire.

**CAUTION:** To reduce the risk of electric shock, do not perform any servicing other than that contained in the instruction manual unless you are qualified to do so. Have the unit serviced by a qualified service technician if;

- The unit has been exposed to rain or water.
- The unit does not seem to operate normally.
- The unit exhibits a marked change in performance.

**LCD:** A Liquid Crystal Display (LCD) screen is a multilayer complex component, containing 311,040 pixels. Pixels can however fail during normal product life. 1 pixel = 0.000003% failure rate, and one pixel failure per year of operation is considered normal and not a cause for concern.

**WEEE:** Disposal of Waste Electrical and Electronic Equipment and/or Battery by users in private households in the European Union. This symbol on the product or on the packaging indicates that this cannot be disposed of as household waste. You must dispose of your waste equipment and/or battery by handing it over to the applicable take-back scheme for the recycling of electronic equipment and/or batteries. For more information please contact your local household waste disposal office.



**CHOKING HAZARD:** Some Products may contain components that are small enough to be swallowed. Please keep out of reach of children.

## Cautions on Using this Product

1. Ensure that the windscreen is free of dirt or grease before placing mount upon it.
2. Do not obscure the view of the road ahead or impede the deployment of any airbags in the event of an accident.
3. When not in use, please disconnect the car adaptor from both the 12/24Vdc outlet in your vehicle and the Dash Cam itself.
4. Only clean the Dash Cam with a soft dry cloth, for tough dirt, apply some neutral detergent diluted in 5 to 6 parts water to a soft cloth.  
Please note that alcohol, thinner, benzene etc could cause damage to the paint or coatings.
5. Avoid making contact with the lenses as damage may be caused.
6. If required clean the glass lens carefully using spectacle lens cleaning fluid on a soft cloth only.
7. The video recordings made by this Dash Cam are intended for personal use only.
8. Publication of the recordings on Youtube, the internet or other methods are subject to the Data Protection Act and the requirements thereof must be adhered to. If the Dash Cam is to be used within a commercial environment, i.e. truck use, then the CCTV regulation apply also, in addition to the Protection Act regulations. This includes labelling to identify the use of CCTV is taking place, the omission of Audio recording and informing the relevant authorities of who controls the data.
9. Video playback upon the Dash Cam which is visible to the driver is prohibited or restricted in some countries or States. Please adhere to these laws.
10. Whilst driving, do not adjust the controls of your Dash Cam as this is a distraction to driving.
11. Before using the Dash Cam on your windscreen, check the state and local laws and ordinances where you drive. Some laws prohibit or restrict the placement of objects on the windscreen of a motor vehicle.  
IT IS THE USER'S RESPONSIBILITY TO MOUNT THE DEVICE IN COMPLIANCE WITH ALL APPLICABLE LAWS AND ORDINANCES.  
Always mount your Nextbase™ Dash Cam in a location that does not obstruct the driver's view of the road. Nextbase™ does not assume any responsibility for any fines, penalties, or damages of your Nextbase™ Dash Cam.  
Nextbase™ accepts no responsibility for any damage or injury caused when the Dash Cam is in use.

Distractions can lead to accidents, and the risk of injury or death. Always keep your eyes on the road, and keep aware of your surroundings.



## Product Warnings

Failure to heed the following warnings could result in an accident or collision resulting in death or serious injury.

### Distraction Warning

This Dash Cam is intended to enhance the situational awareness when used properly. If used improperly, you could become distracted by the display, which could lead to an accident causing serious personal injury or death. **DO NOT** seek to access the information stored on the Dash Cam or change the device settings whilst driving. Information stored on the Dash Cam should be reviewed only when your vehicle is stationary, and you are parked in a safe place in compliance with local laws.

The Dash Cam settings should only be changed when your vehicle is stationary, and you are parked in a safe place in compliance with local laws. Always maintain awareness of your surroundings and do not stare at the display or become distracted by the display. Focusing on the display could cause you to miss obstacles or hazards. Use the Dash Cam at your own risk.

Do not change settings, or access any functions requiring prolonged use of the Dash Cam controls while driving. Pull over in a safe and legal manner before attempting such operations.

Video playback upon devices with displays which are visible to the driver, is prohibited or restricted in some countries or states. Please adhere to these laws.

### Vehicle Installation Warnings

When installing the Dash Cam in a vehicle, do not place the Dash Cam where it obstructs the driver's view of the road or interferes with vehicle operating controls, such as the steering wheel, foot pedals, or transmission levers. Do not place unsecured on the vehicle dashboard.

Do not place the Dash Cam in front of or above any airbag.

### Battery Warnings

Lithium-ion batteries are used in most Nextbase™ Dash Cams. If these guidelines are not followed, batteries may experience a shortened life span or may present a risk of damage to the Dash Cam, fire, chemical burn, electrolyte leak, and/or injury.

- Do not disassemble, modify, remanufacture, puncture, or damage the Dash Cam or batteries.
- Do not remove or attempt to remove the non-user replaceable battery.
- Do not expose the Dash Cam to fire, explosion, or other hazard.
- Do not expose the Dash Cam to rain or water.

### Magnet Warnings

Both the Dash Cam and its mount may contain magnets. Under certain circumstances, magnets may cause interference with some internal medical devices, including pacemakers and insulin pumps.

Devices and mounts that contain magnets should be kept away from such medical devices. Magnets may cause damage to some electronic devices, including hard drives in laptop computers and bank / credit or membership cards. Use caution when devices and mounts that contain magnets are near electronic devices or bank / credit or membership cards.



## Usage Precautions

Failure to heed the following notices could result in personal injury or property damage, or negatively impact the Dash Cam functionality.

### Battery Precaution

- Do not immerse or expose the Dash Cam or batteries to rain, water or other liquids.
- Do not leave the Dash Cam exposed to a heat source or in a high-temperature location, such as in the sun or in an unattended vehicle. To prevent the possibility of damage, remove the Dash Cam from the vehicle or store it out of direct sunlight, such as in the glove box.
- Do not operate the Dash Cam outside of the following temperature range:  
from -20° to 45°C (from -4° to 113°F).
- When storing the Dash Cam for an extended time period, store within the following temperature range: from 0° to 25°C (from 32° to 77°F).
- Do not use a power and/or data cable that is not approved or supplied by Nextbase™.
- Contact your local waste disposal department to dispose of the Dash Cam/batteries in accordance with applicable local laws and regulations.

### Windshield Mounting Legal Restriction Precaution

Before using the Dash Cam on your windscreen, check the state and local laws and ordinances where you drive. Some laws prohibit or restrict the placement of objects on the windshield of a motor vehicle.

IT IS THE USER'S RESPONSIBILITY TO MOUNT THE DEVICE IN COMPLIANCE WITH ALL APPLICABLE LAWS AND ORDINANCES.

Always mount your Nextbase™ Dash Cam in a location that does not obstruct the driver's view of the road. Nextbase™ does not assume any responsibility for any fines, penalties, or damages that may be incurred as a result of any state or local law or ordinance relating to the use of your Nextbase™ Dash Cam.

### Camera Legal Requirements Precaution

In some jurisdictions it could be considered an invasion of privacy rights to take or publicly display photographs or videos of people or their vehicles using this product. It is your responsibility to know and comply with applicable laws and rights to privacy in your jurisdiction and in any jurisdiction in which you may use this device. Video recordings made by this Dash Cam should be for personal use only.

Publication of the recordings on YouTube, the internet or other methods is subject to the data protection legislation and the requirements thereof must be adhered to. Such data protection legislation may prohibit the use and dissemination by you of Dash Cam footage or may impose restrictions on it – we recommend that you check the legal requirements with your legal advisor before disseminating any Dash Cam footage.

If the Dash Cam is to be used within a UK commercial environment, i.e. truck use, then the CCTV regulations apply in addition to the Data Protection Act regulations. This includes labelling to identify the use of CCTV is taking place, the omission of Audio recording and informing the relevant authorities of who controls the data. For use in a commercial environment in non-UK countries, please refer and adhere to local regulations and requirements. For non-UK operation, specific legal requirements may apply where Dash Cams are to be used in a commercial or employment context - again, we recommend that you check the legal requirements with your legal advisors prior to commencing use of Dash Cams in commercial or employment contexts.

## Notices

### G Sensor Notice

The G Sensor within the Dash Cam measures forces exerted upon it, with reference to one G which is the nominal force exerted upon us when stationary on the earth's surface.

The G Sensor will also trigger to protect any recording currently in progress, if a pre-determined threshold of force is exceeded.

The G Sensor protection will be adversely affected if the Dash Cam is NOT mounted in the vertical direction i.e. with the lens pointing to or from the direction of travel.

G Force information derived from a G Sensor is not warranted to be totally accurate at all times, as it is derived from the G Sensor through a sampling method over time. The precision of the G Sensor value recorded depends upon when the acceleration took place at the instance of the sample taken.

The thresholds to trigger the video protection rely upon a trigger value being exceeded between two successive samples, in any one of the three G Sensor axis.

If the Automatic G Sensor protection does NOT trigger during an event, then the Protect button should be pressed, in order to protect the file. Protecting the file can also be performed using the Playback function upon the Dash Cam, or through the MyNextbase Connect™ App for applicable Wi-Fi enabled models.

## Innovation, Science, and Economic Development Canada Compliance

This device complies with Innovation, Science and Economic Development Canada license-exempt RSS standard(s).

Operation is subject to the following two conditions:

- (1) this device may not cause interference, and
- (2) this device must accept any interference, including interference that may cause undesired operation of the device.

# Declaration of Conformity

## Declaration of Conformity

**We, Portable Multimedia Limited.  
Dorna House Two,  
52 Guildford Road,  
West End, Surrey.  
GU24 9PW  
United Kingdom**

Declare under sole responsibility that the products:-

Product Name: NEXTBASE In Car Cam  
Model number: NBDVR222

To which this declaration relates, is in conformity with the following standards,

2014/30/EU (EMC Directive)  
EN 55032:2015  
EN 55035:2017  
EN 61000-3-2:2014  
EN 61000-3-3:2013  
EN 60950-1: 2006 + A11:2009+A1 2010+A12:2011+A2:2013 (LVD)  
2011/65/EU + EU 2015/863 (RoHS directive)  
2012/19/EU (WEEE Directive)  
EC 1907/2006 (REACH)  
IEC 61000 -4-2:2008 IEC61000-4-3:2006+A1:2007+A2:2010  
IEC 61000-4-4:2012, IEC 61000-4-5:2014, IEC 61000-4-6:2013  
IEC 61000-4-8:2009, IEC 61000-4-11:2004+A1:2017  
EN 301 489-1 V2.2.1: 2019-03  
EN 301 489-17 V3.2.0:2017-03  
EN 301 489-19 V2.1.1: 2019-04  
EN 300 328 V2.1.1: 2016-11 (BT3.0, BT4.0 & Wi-Fi)  
2014/53/EU & EN 62311:2008 (RED)  
ETSI EN 303 413 V1.1.1: 2017-06 (GNSS)

Supplementary information:

This product complies with the requirements above and carries the CE mark accordingly.

Caerphilly, United Kingdom  
(Place of issue)

20<sup>th</sup> March 2019  
(Date of issue)

Graham Lambert  
(Name of authorised person)

  
(Technical Director)  
(Signature of authorised person)  
Telephone +44 2920 866429

Declaration of Conformity

# FCC Statement

This device complies with Part 15 of the FCC Rules. Operation is subject to the following two conditions:

- (1) this device may not cause harmful interference, and
- (2) this device must accept any interference received, including interference that may cause undesired operation.

This equipment has been tested and found to comply with the limits for a Class B digital device, pursuant to Part 15 of the FCC Rules. These limits are designed to provide reasonable protection against harmful interference in a residential installation. This equipment generates, uses and can radiate radio frequency energy and, if not installed and used in accordance with the instructions, may cause harmful interference to radio communications. However, there is no guarantee that interference will not occur in a particular installation. If this equipment does cause harmful interference to radio or television reception, which can be determined by turning the equipment off and on, the user is encouraged to try to correct the interference by one or more of the following measures:

- Reorient or relocate the receiving antenna.
- Increase the separation between the equipment and receiver.
- Connect the equipment to an outlet on a circuit different from that to which the receiver is connected.
- Consult the dealer or an experienced radio/TV technician for help.
- This appliance and its antenna must not be co-located or operated conjunction with any other antenna or transmitter.
- A minimum separation distance of 20cm must be maintained between the antenna and the person for this appliance to satisfy the RF exposure requirements.

## FCC CAUTION:

This product does not contain any user-serviceable parts. Repairs should only be made by an authorised Nextbase™ service centre. Unauthorized repairs or modifications could result in permanent damage to the equipment, and void your warranty and your authority to operate this device under Part 15 regulations.

# FCC - Supplier's Declaration of Conformity Statement

## SUPPLIER'S DECLARATION OF CONFORMITY (47 CFR Section 2.906).

We; Tank Design  
(The responsible party, who must be located in the United States)

Hereby, Declare that the essential requirements set out in the 47 CFR Sections 2.906 of FCC, have been fully fulfilled on our product with indication below:

### 1. Applicant's Info

Company Name: Portable Multimedia Ltd  
Mailing Address: Unit 2, Caerphilly Business Park, Van Road, Caerphilly. CF83 3ED. UK  
Contact: Graham Lambert  
Tel: +44 02920 866429  
Email Address: support@nextbase.com

### 2. Product Info

Product Name: Dash Cam  
Model No.: NBDVR222  
Brand Name: Nextbase

### 3. Applied Standard

Standards  
FCC Part 15 Subpart B: 2017

Report No. WTS19S02008902E

### 4. Test Firm Used to Take Measurements:

Name: Waltek Services (Shenzhen) Co., Ltd.  
Address: 1/F, Fukangtai Building, West Baima Rd Songgang Street, Baoan District,  
Shenzhen, Guangdong, People's Republic of China, 518105  
Contact Name: Philo Zhong  
Tel: +86 755 8355 1033 802  
Email: CB@waltek.com.cn  
Designation No.: CN1201  
FRN: 523476

### 5. FCC Marking



### 6. Responsibilities and obligations

Strictly follow the FCC rules of 2.906, 2.908, 2.909.

### 7. Applicant's Authorisation

Company Name: Portable Multimedia Ltd  
Mailing Address: Unit 2, Caerphilly Business Park, Van Road,  
Caerphilly. CF83 3ED. UK  
Contact person: Graham Lambert  
Signature: *G. K. Lambert*  
Email Address: support@nextbase.com  
Tel: +44 02920 866429  
Date: 20th March 2019

### 8. Responsible party in US.

Company name: Tank Design  
Mailing Address: 158 Sidney Street, Cambridge, MA 02139, United States  
Contact person: Mr Scott Watts  
Signature: *Scott Watts*  
Email address: SWatts@tankdesign.com  
Tel: (617) 388-8380  
Date: 20th March 2019



## Product Specification

Model Number / Name	NBDVR222
Power Requirements	5V / 1.5A
Power Supply	12-24Vdc Car Power Cable (supplied) Fuse Type: 32mm / 2A Output: 5Vdc
	Hardwire Kit also available to purchase for a hidden, permanent power supply.
Sensor Resolution	2.12M Pixel (1936 x 1097)
Lens - Type / Angle / Aperture	6G / 140° / F1.6
Recording Resolution	1920 x 1080 @30fps day & night
Photo Resolution	1920 x 1080
Screen Size	2.5"
Screen Resolution	732 (W) X 240 (H) pixels x RGB (720)
Screen Ratio	16:9
Card Reader	MicroSD, Class 10, U1 up to 128GB
SD Card (Recommended Type)	8-128GB SDHC, Class 10 (48mb/s) For best results, use a recognized brand.
SD Card Recorded File Capacity (based on default settings)	8GB MicroSD = 60 minutes of recording 16GB MicroSD = 120 minutes of recording 32GB MicroSD = 240 minutes of recording 64GB MicroSD = 480 minutes of recording 128GB MicroSD = 960 minutes of recording
Recording Format	MP4
Internal Battery	Lithium-Polymer 3.7V / 280mAh (approx. 15 mins recording time) Battery design allows the 'Auto Power Off' feature to function in event of power loss within the vehicle. It is not intended as an alternative power source to replace the supplied car adaptor.
Unit Dimensions	82 x 46 x 46
Unit Weight	79g

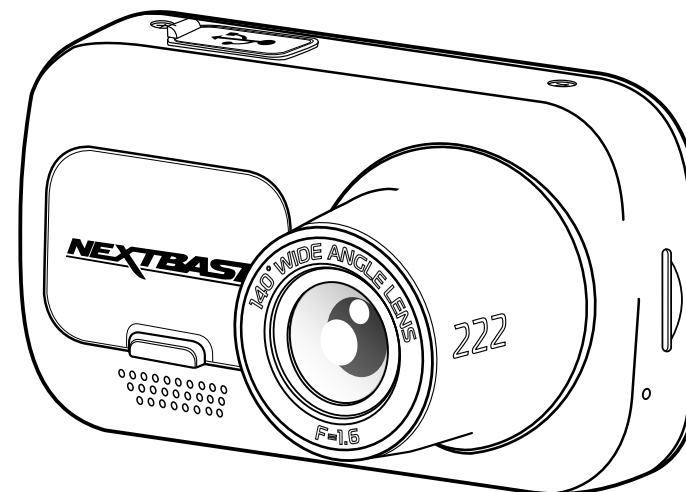

Mac is a registered trademarks of Apple Inc. in the United States and other countries.  
Windows is a registered trademark of Microsoft Corporation in the United States and other countries.  
MicroSD™ and the microSD logo are trademarks of SD-3C, LLC.  
Other trademarks and trade names are those of their respective owners.

## Package Contents

Please check the contents of your Nextbase Dash Cam product.

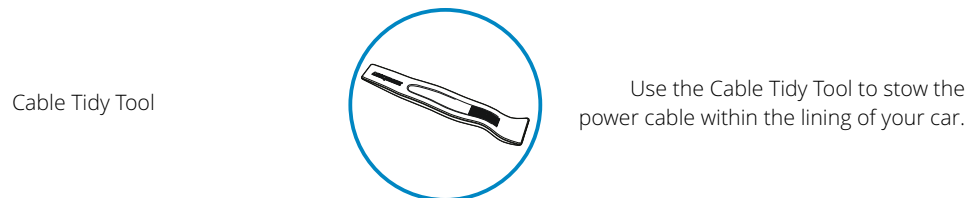
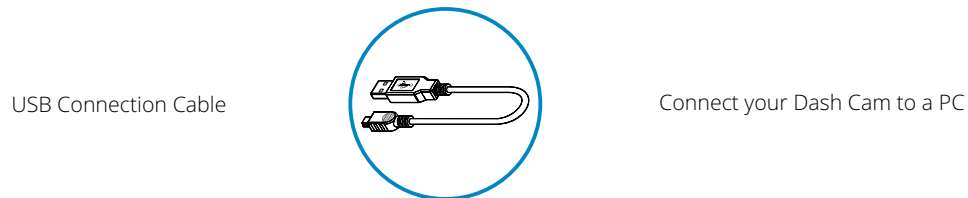
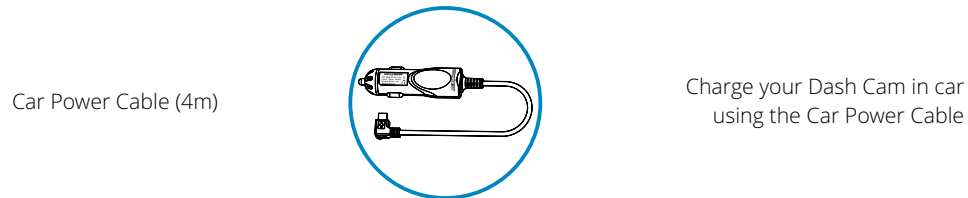
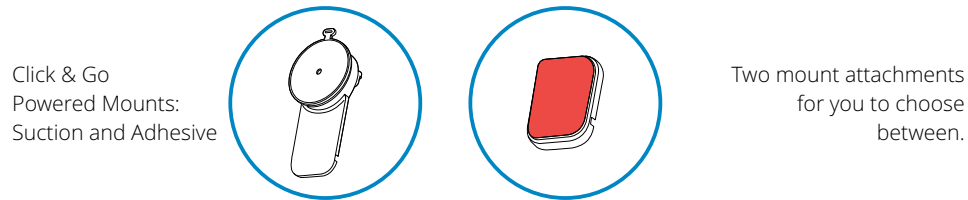

Product appearance may differ slightly to that shown above.

## Product Features

Thank you for purchasing this Nextbase™ Dash Cam product, in this section we will outline some of the features available with this dash cam.

### HD Recording Capability

1080p HD recording at 30 fps, to record the road ahead.

### HD Display

Bright, clear, high definition 2.5" screen with IPS technology for a wide viewing angle.

### Click & Go Pro Powered Mount

Our exclusive Click and Go Pro powered magnetic car mount to easily install and remove your Dash Cam with just one hand. Supplied with both adhesive and suction fittings.

### G Sensor / File Protection

In the event of an impact the device will automatically 'protect' the recording, stopping the file from being over-written. This can also be performed manually, by pressing the 'protect' button. Individual files can also be 'protected' when viewed within playback mode.

### Automatic Start / Stop Technology

As soon as the vehicle ignition is turned on, your Dash Cam will start to record automatically. When the ignition is turned off, the Dash Cam will perform an automatic shutdown process.

### Intelligent Parking Mode

Intelligent Parking Mode triggers recording automatically when motion is detected, keeping your car safe when parked.

### Built-in Microphone & Speaker

Record audio to compliment the video recordings.

### Nextbase Cloud™ Service

View and share your footage online using the MyNextbase Cloud™ service. Upload your video to the Nextbase™ server to get a shareable link to send to friends, insurers, and social media. Upload your videos via the file upload area on [Mynextbase.com](http://Mynextbase.com). The uploaded file will be deleted after 30 days, when the link will also expire.

## Camera Parts and Controls

See below to identify the parts and controls of your Dash Cam

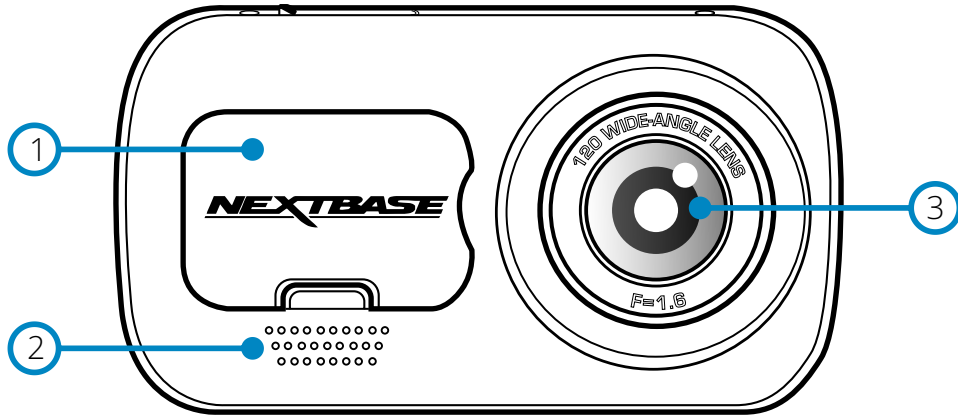

- ① **Dust Cover**  
Mounting point located under the dust cover.
- ② **Speaker**  
Integrated speaker for audio playback.
- ③ **Camera Lens**  
Wide angle 140°.
- ④ **Power Button**  
Press and hold for 2 seconds to turn the Dash Cam On/Off.
- ⑤ **Menu Button**  
Press to open the Dash Cam's menu system.
- ⑥ **Mode Button**  
Press to select video/photo/playback modes.

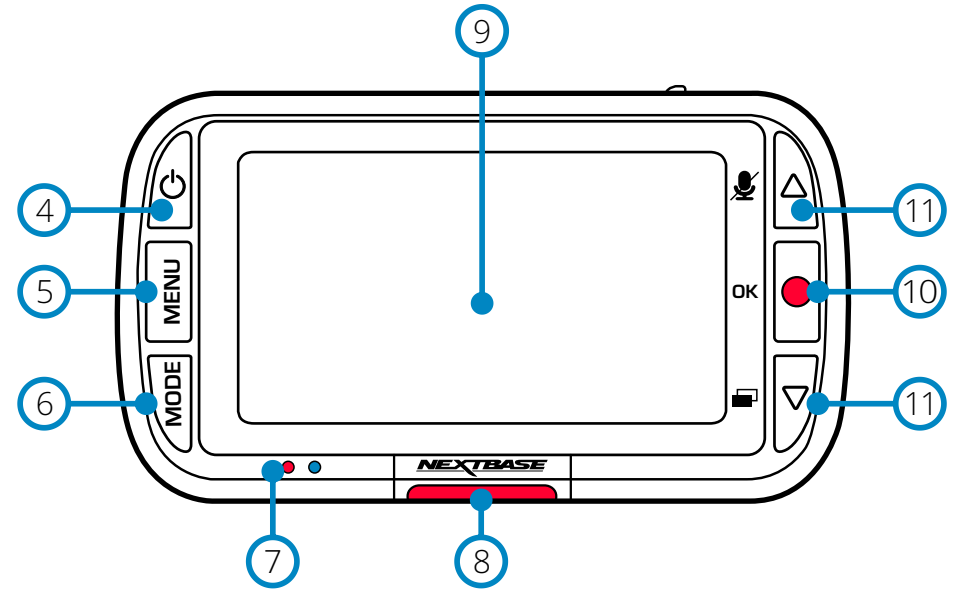

- ⑦ **LEDs**  
Right: Blue  
- The Blue LED will be on while the Dash Cam is charging. It will turn off when charging is complete, even if the Dash Cam is still plugged in.  
Left: Red  
- The Red LED is permanently on while the Dash Cam is active. It will flash while recording.
- ⑧ **Protect Button**  
Press whilst recording to protect the current file in event of an emergency situation.
- ⑨ **Screen**  
2 Inch High Resolution Screen.
- ⑩ **Record**  
Video Mode: Press to Start/Stop recording  
Photo Mode: Press to take photo  
In the Menu: Select/OK
- ⑪ **Up/Down Buttons**  
In the Menu: Use to navigate the menus within the camera.  
Video Mode: Up button toggles audio recording On/Off. Down button toggles screen On/Off  
Playback Mode: Scroll through your videos/photos.

## Camera Parts and Controls (cont.)

See below to identify the parts and controls of your Dash Cam

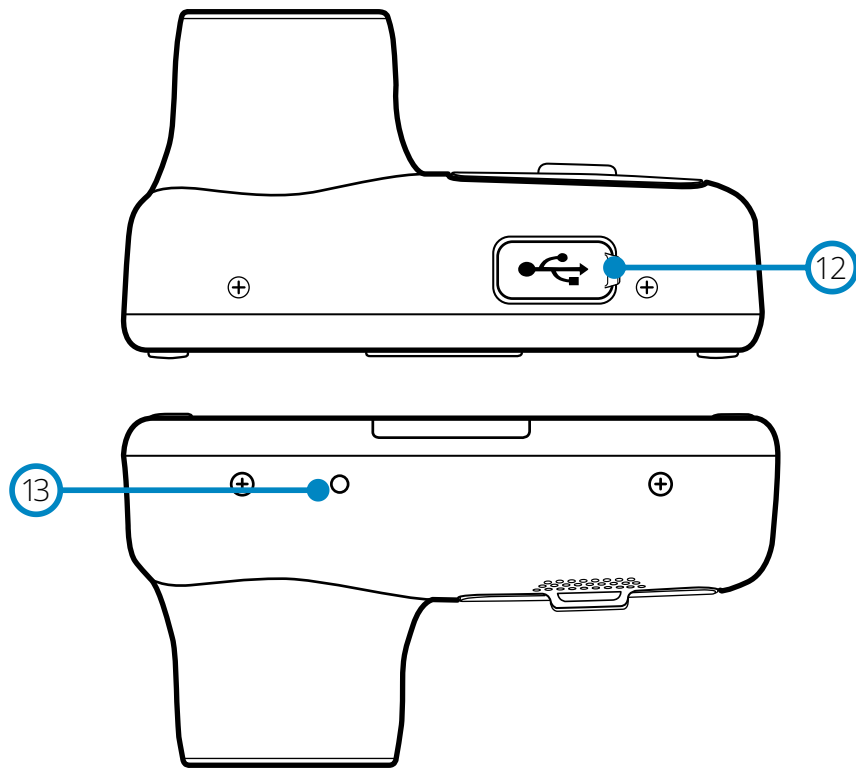

**12** **USB Cover**  
USB-PC port located under the dust cover.

**13** **Reset Button**  
Press to force a hard restart of the Dash Cam.

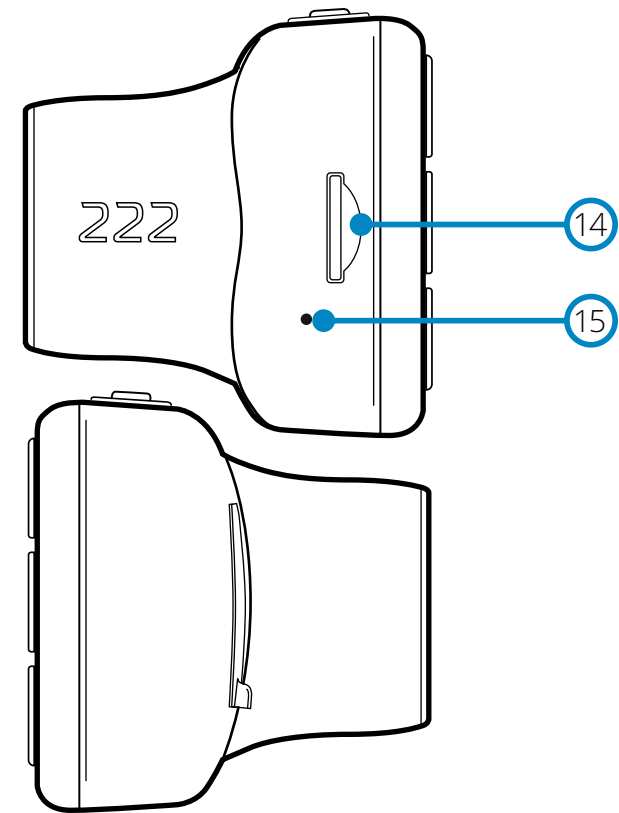

**14** **MicroSD Card Slot**  
Insert the MicroSD card here, taking care that the gold contacts are facing towards the screen side of the Dash Cam.

**15** **Microphone**  
Built-in microphone to record audio for your videos.

## In Vehicle Installation

Please follow the instructions below for the first-time installation of the Dash Cam. For day to day use, simply remove the camera from the mount as required.

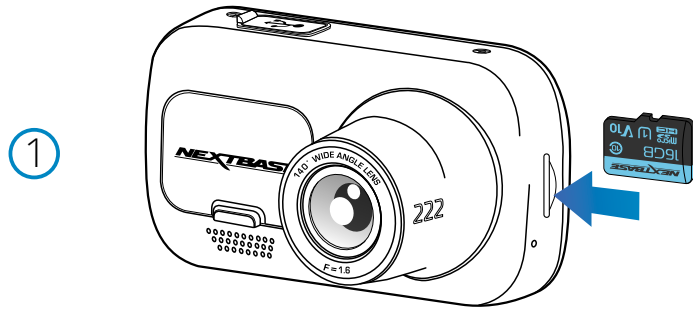

### 1 Insert MicroSD Card

Insert a suitable MicroSD card (Class 10, U1 minimum 48/Mbps) in to the Dash Cam, taking care that the gold contacts are facing towards the LCD screen side of the Dash Cam. Push the memory card until it clicks into place.

#### Note:

- Use the edge of a small coin (or similar object) to push the memory card in place if required. Take care that card has 'clicked' into place, a second push inwards will release the memory card.
- For best results, we recommend using Nextbase™ branded SD cards.
- Do not remove or insert the memory card when the Dash Cam is turned on. This may damage the memory card.

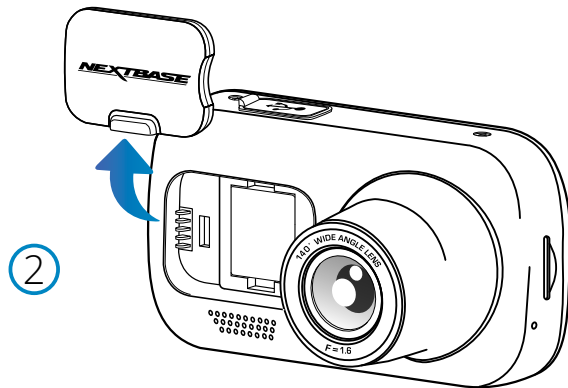

### 2 Remove dust cover from the Dash Cam

Remove the dust cover that is located on the front of the Dash Cam to gain access to the mounting point.

To remove the dust cover, lift the cover away from the body of the Dash Cam.

#### Note:

- If the Dash Cam is not to be used for a period of time replace the dust cover to help keep the components free of dust or other contaminants.

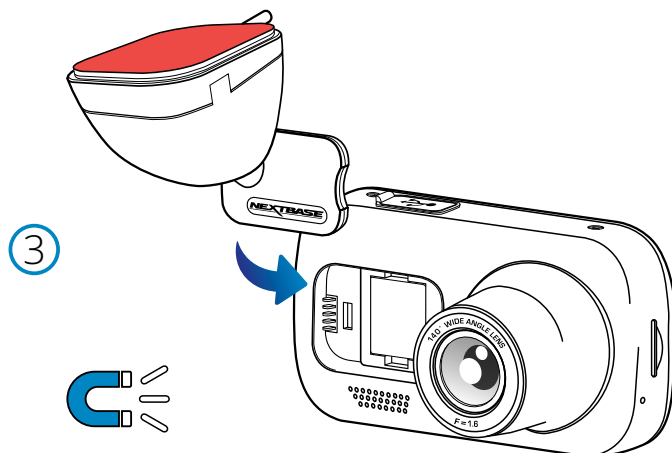

### 3 Attach the mount to the Dash Cam

Place the mount in space under the dust cover on the Dash Cam. Once in place, magnets within the mount and camera will hold the two parts together.

See page 16 for more information on changing mounts attachments.

4

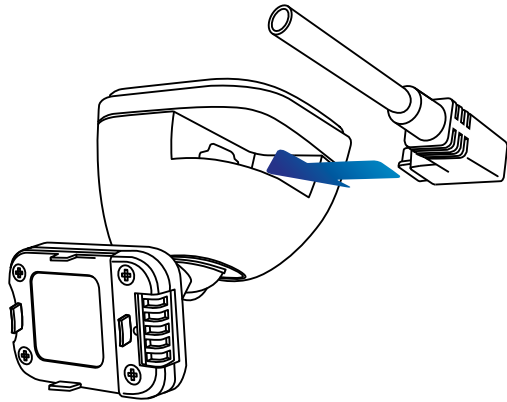

**4 Connect car power cable**

Connect the supplied car power cable to the Dash Cam Mount's USB port. Do NOT connect the power cable to the USB port on the Dash Cam.

5

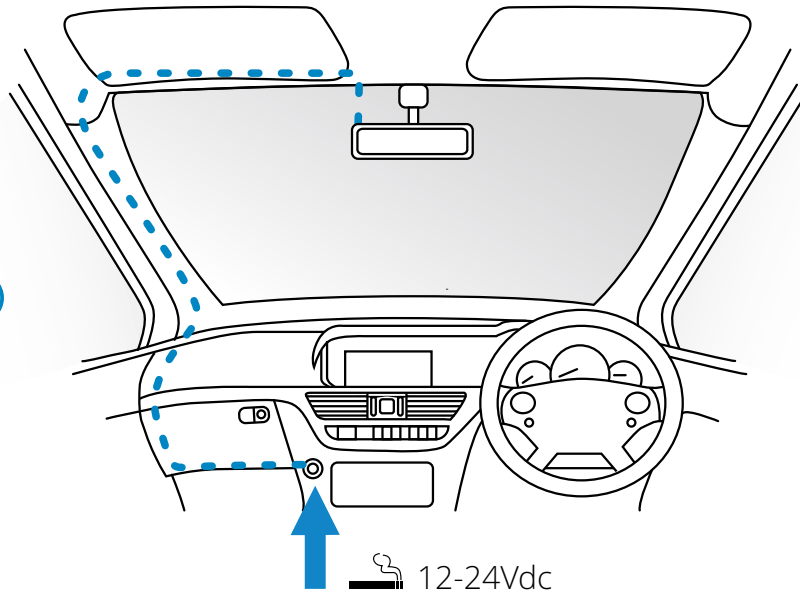

**5 Plug the power cable into the 12-24Vdc outlet of your vehicle**

The Dash Cam will automatically power on and start recording once power is available. In some vehicles this will be when connections are made, for others the Dash Cam will power on once the ignition has been turned on.

Also available to purchase is a Nextbase Hardwire Kit. This connects your Dash Cam directly to the vehicle's fusebox to power it leaving your 12Vdc outlet available for Phone / Sat Nav charging. The Nextbase™ Hardwire Kit includes the necessary 12-24Vdc to 5Vdc convertor and battery protection circuitry. See pages 9-10 of the Nextbase™ Accessories Manual for further information.

Route the power cable around the windshield to the 12-24Vdc socket, ensuring that your view is not obstructed, and that the cable is not a distraction. Use the cable fitting tool (bottom, left) included with your Dash Cam to more easily open the lining of your vehicle, within which you can stow the cable. See page 17, 'Positioning your Dashcam' for more details.

**Note:**

- Do NOT wire the Dash Cam directly to a 12Vdc supply by cutting the cigarette plug off the end of the cable, or permanent damage will result.

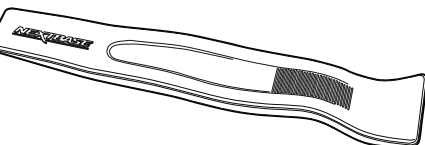

Cable Fitting Tool (included with your Dash Cam)

## In Vehicle Installation (cont.)



- 6 Remove the adhesive cover layer**  
Peel back the red cover layer to expose the adhesive surface, ready to mount on your windscreen.

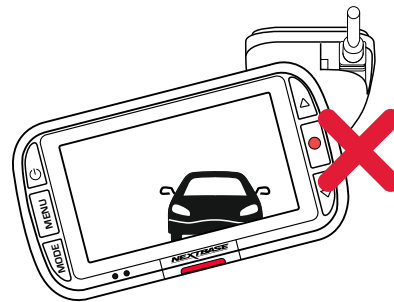
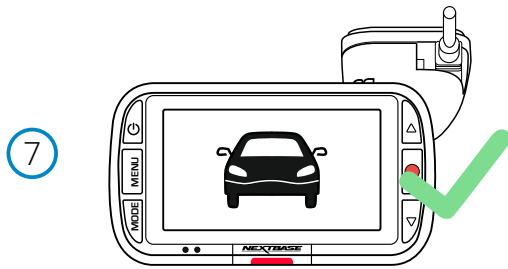

- 7 Straighten the Dash Cam**  
Ensure that the Dash Cam is horizontal and faces straight out of the windscreen. Ensure that objects on the Dash Cam display appear level, and adjust as required.

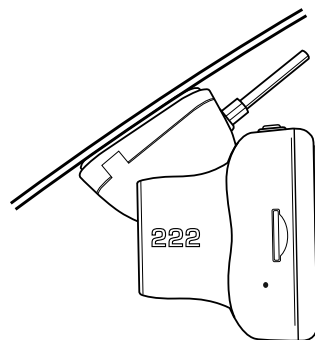
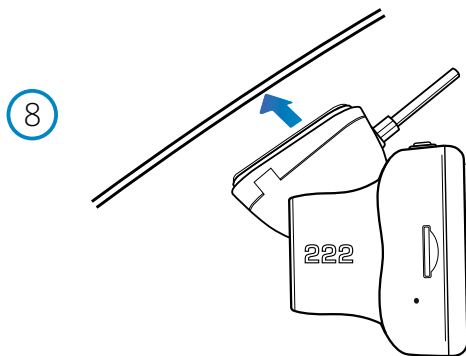

- 8 Attach the Dash Cam to the windscreen**  
When you are satisfied with the placement and orientation of the Dash Cam, firmly place the mount on the windscreen.

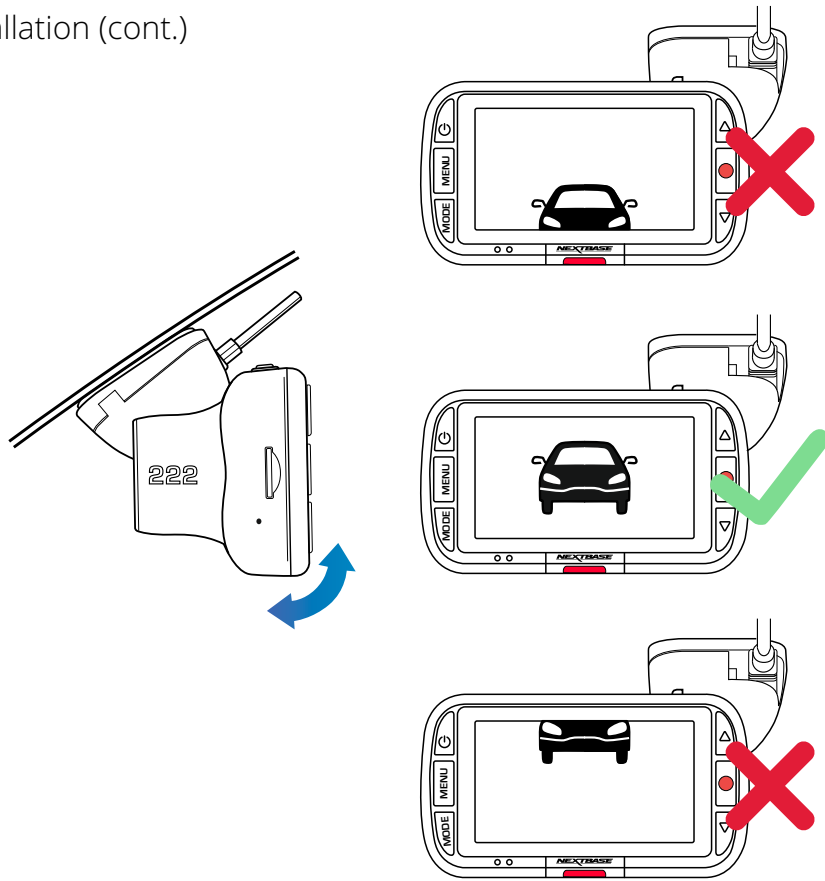

9

### 9 Adjusting the Dash Cam

With the mount attached to the windscreen, ensure that objects on the Dash Cam display are level and adjust as required. Ensure that the road ahead is at the centre of the image, in the central third of the display. If too much of the sky is visible it may risk underexposing details on the road; ensure that the road ahead is clearly visible on the Dash Cam display. Do NOT attempt to adjust the Dash Cam while driving.





## Positioning Your Dash Cam

Please read and follow the notes below for the safe operation of your Dash Cam within your vehicle.

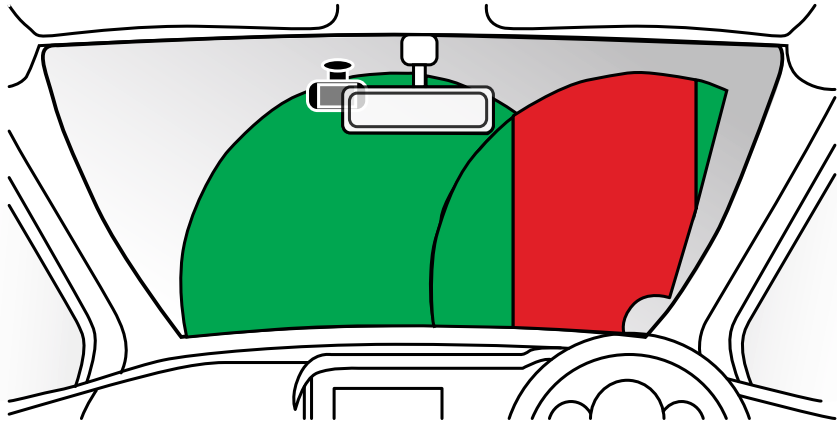

Before installing the Dash Cam on your windscreen, check the state and local laws and ordinances where you drive. Some laws prohibit or restrict the placement of objects on the windscreen of a motor vehicle. IT IS THE USER'S RESPONSIBILITY TO MOUNT THE DEVICE IN COMPLIANCE WITH ALL APPLICABLE LAWS AND ORDINANCES.

Always mount your Nextbase™ Dash Cam in a location that does not obstruct the driver's view of the road. Nextbase™ does not assume any responsibility for any fines, penalties, or damages that may be incurred as a result of any state or local law or ordinance relating to the use of your Nextbase™ Dash Cam.

As per the installation instructions, you must install the Dash Cam so it does NOT obstruct the driver's view of the road (red, above), preferably on the passenger side of the vehicle and behind the rear view mirror. The Dash Cam needs to view through a clear section of windscreen in an area swept by the windscreen wipers (green, above). However, the Dash Cam should be installed so as not to intrude significantly within the wiped area. A 40mm intrusion into the green wiped area is the maximum permitted by UK law.

### Hiding the Cable:

Make sure the hanging cable does not obstruct your view out of your rear window. Ensure that there are no kinks in the cable as you are stowing it. If necessary, use the cable tidy tool supplied with your Dash Cam; this can be used to help pry open the lining of your car (see illustration below, right).

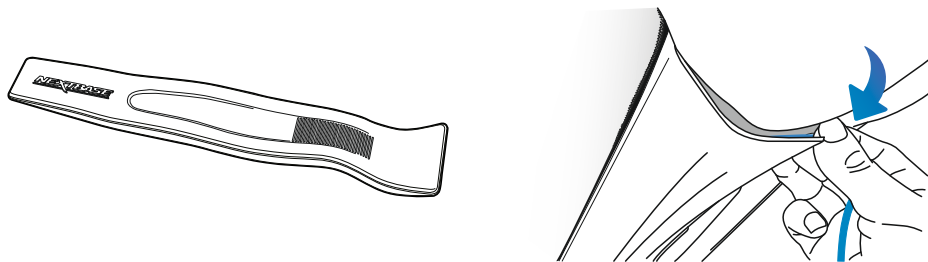

## Notes On Positioning Your Dash Cam

- Do NOT mount the Dash Cam in front of the driver, as depicted by the red area in the illustration to the left of this page.
- When installing the Dash Cam in a vehicle, always place the device securely against the windscreen and where possible conceal the power cable under trim.
- Make sure that the Dash Cam power cable does not interfere with the drivers operating controls, such as the steering wheel, pedals or gear levers.
- Do NOT mount the Dash Cam in front of an airbag field of deployment or in a position to obscure any mirrors.
- Clean the windscreen at the point of location, prior to fitting the Dash Cam, also, applying some moisture to the suction cup may be beneficial, to ensure absolute adhesion.
- It is recommended NOT to operate the Dash Cam whilst driving. The automatic Start-Stop technology incorporated within the device negates any need to operate the controls whilst driving.
- Adjust any settings or review recordings whilst stationary, not whilst driving.
- After the preliminary SETUP has been carried out upon the Dash Cam, adjust the Screen Saver setting to ON; this will blank the screen automatically 30 seconds after starting the vehicle and therefore the screen will NOT be a distraction in any way to the driver.

## Accessories

Multiple accessories can be purchased for your Nextbase™ Dash Cam, including a Hardwire Kit and Polarising Filter that can effect how best to set up your Dash Cam.

For more information on how to position and use these products, download the '*Nextbase Accessories Manual*' PDF at [www.nextbase.com](http://www.nextbase.com)

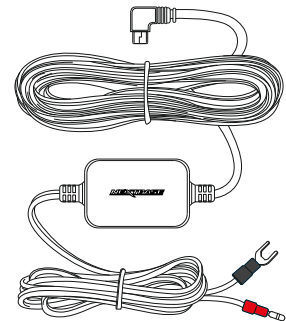

## Changing Mount Attachments

Follow the instructions below to switch between mounts attachments; 3M adhesive or suction. To attach each mount, align the pins on the mount with the holes on the adhesive/suction attachment and slide firmly to the right until you hear the pieces click into place. To remove the top, simply do the reverse, slide it to the left until you can lift it off of the mounting pins.

Ensure the windshield is free of grease and dirt before mounting; if necessary, clean with a warm, clean cloth. Ensure that the Mount and Dash Cam do not obstruct the driver's view.

## Removing Adhesive Residue

If you wish to remove the adhesive mount from your windshield, use hot soapy water or an alcohol based solution to get rid of any sticky residue and ensure that your windshield remains clean and clear. Leaving residue on the windshield for an extended period of time will make it harder to remove. If hot water or an alcohol based solution proves ineffective, it may be necessary to use a small sharp blade. If this is the case, protect your fingers and use the blade flat against the surface of the glass to avoid causing scratches.

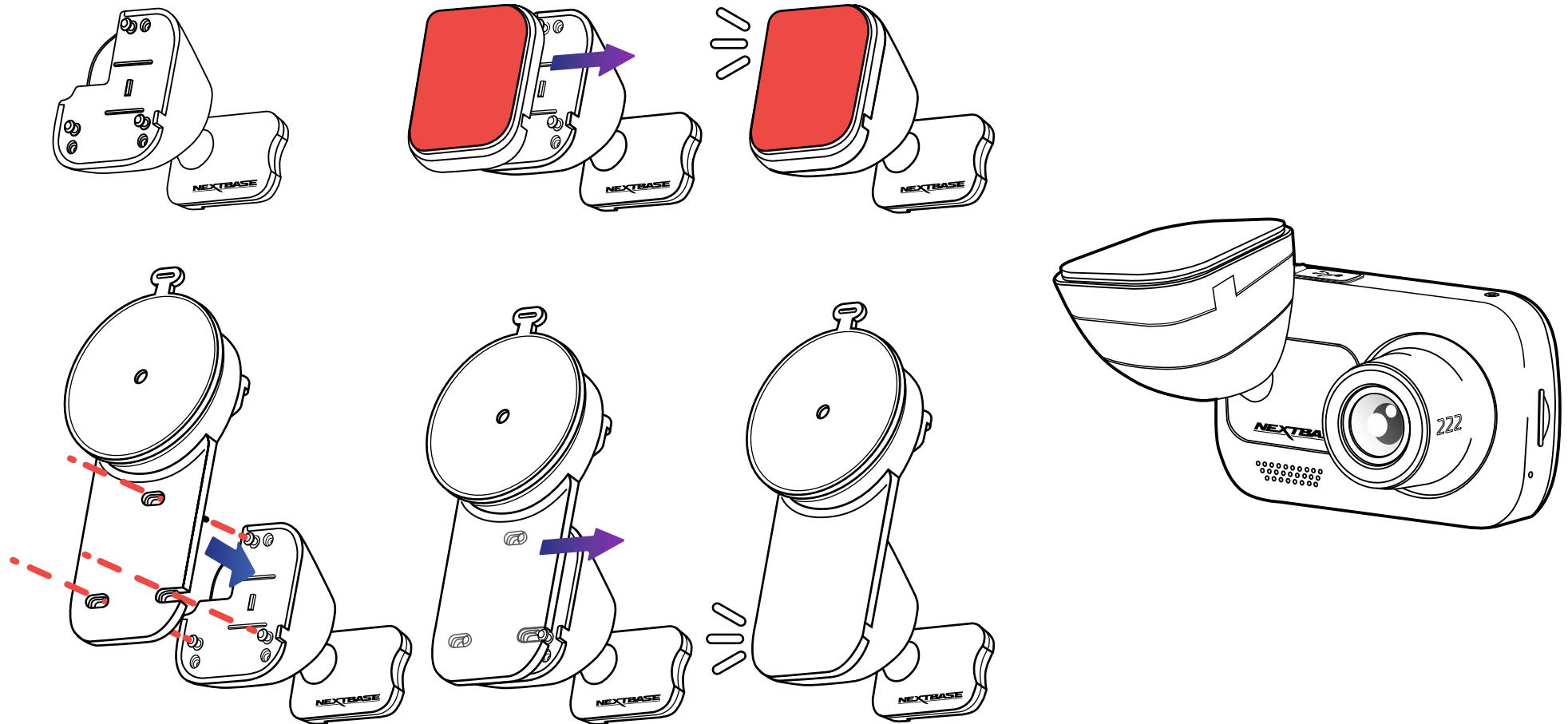

# First Time Use

To ensure the set up of this Dash Cam is as quick and simple as possible, there is an easy to follow 'First Time Use' menu.

This menu is used to set Language, Time, and Date.

This menu will appear when:

1. The Dash Cam is first turned on.
2. There has been a Firmware Update applied to the Dash Cam and 'Keep User Settings' has been set to OFF. If It is set to ON, your Dash Cam will start normally, with your settings intact.
3. After the Dash Cam's settings have been reset, by using the 'Default Settings' option in the Setup Menu.

Follow the on-screen instruction to select the Language, Time, and Date.

### Note:

- The First Time Use menu is in place to get you up and running quickly and smoothly.
- The settings you choose during First Time Use can be changed at any later time in the setup menus.

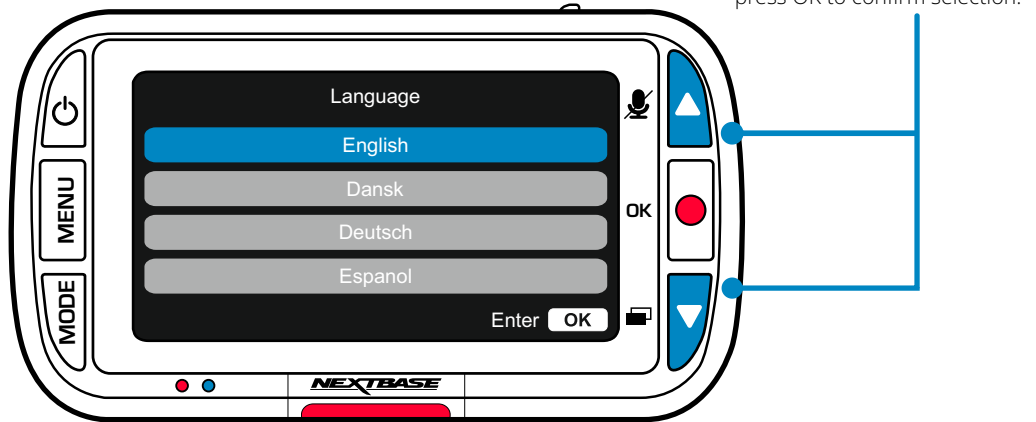

Use the UP and DOWN buttons to select required function and press OK to confirm selection.

## First Time Use Screens

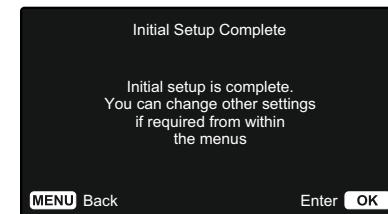
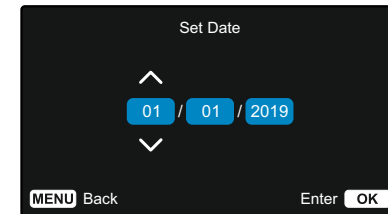
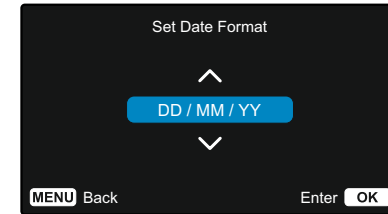
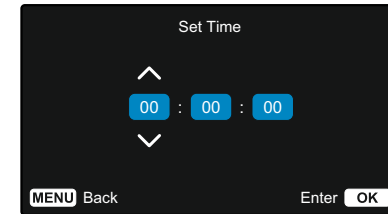
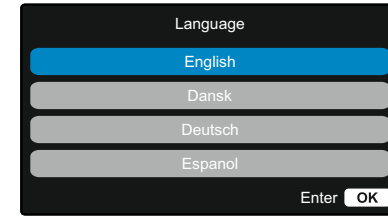

## Menus

Press the 'Menu' button to enter the Dash Cam's 'Video Menu' system.

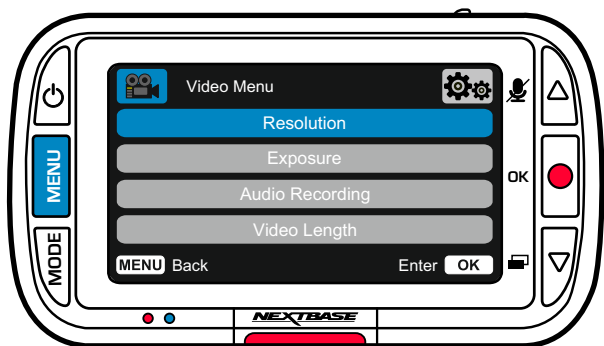

The default settings have been carefully selected to allow you to use your Dash Cam without the need to change any settings. However, should you wish to change a setting then please see below:

- Use the up and down buttons to highlight the function that you'd like to change and press the OK button to enter the settings submenu.
- Once in the submenu, use the up and down buttons to highlight the required setting and then press OK to confirm your selection and return to the Video Menu.
- Press the MENU button twice to return to video mode.

### Notes:

- Menus are not accessible whilst the Dash Cam is recording.
- Within the Setup Menu which is accessed by pressing the MENU button twice, there is a 'Default Settings' option to allow you to reset the Dash Cam to the factory defaults, if required.

## Video Menu Options

- 1 Resolution**  
Change your Dash Cam's recording resolution  
  
**Options:** 1080pP, 720P, 720P @ 60FPS  
**Default:** 1080P
- 2 Exposure**  
Adjust the exposure level for different lighting conditions.  
  
**Options:** Values range from -6 to +6  
**Default:** 0

- 3 Audio Recording**  
Turn On/Off the microphone for video recording

**Options:** On and Off  
**Default:** On

- 4 Video Length**  
Set the length of the individual recorded video files. The Dash Cam will continue recording, filling the memory card. When the memory card becomes full, the oldest file will be automatically deleted to make space for the new recording.

**Note:** Protected Files will not be overwritten. If the SD Card becomes full you will be prompted to format/clear the SD Card.

**Options:** 1 minute, 2 minutes, 3 minutes  
**Default:** 1 minute

- 5 Time & Date Stamp**  
Turn On/Off the time and date stamp shown at the bottom of the screen on recorded files.

**Options:** On and Off  
**Default:** On

- 6 G Sensor**  
Turn off or adjust the sensitivity of the internal G Sensor. The G Sensor detects forces which will protect the current recording in the event of a collision. The higher the G Sensor sensitivity, the less force will be needed to trigger automatic file protection.

**Note:** If you have a car with firm suspension you may wish to adjust this to LOW. Likewise if you have soft suspension you may wish to adjust this to HIGH

**Options:** Off, Low, Medium, High  
**Default:** Medium

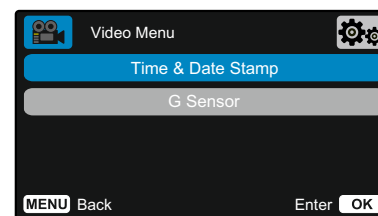
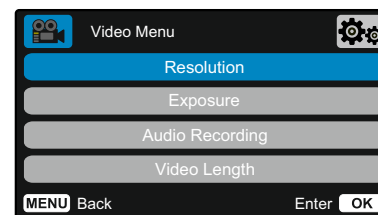

## Menus (cont.)

Press the 'Menu' button again when in 'Video Menu' to enter the Dash Cam's 'Setup Menu' system.

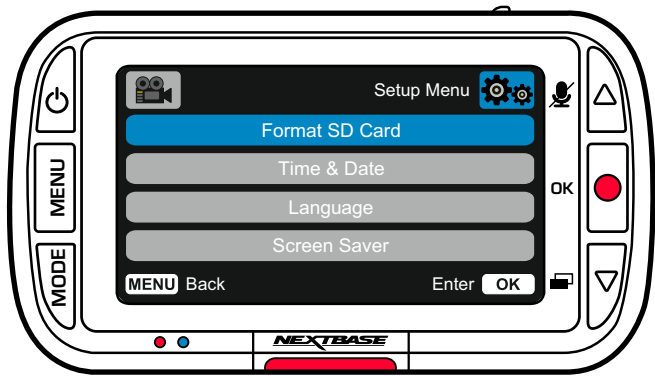

## Setup Menu Options

- 1** **Format SD Card**  
Format the inserted SD card. This will delete all content.

**Note:** For stable performance, it is recommended that you format the memory card every 2-3 weeks. You should only do this **AFTER** you've backed up any files from the card that you may want to keep.
- 2** **Time & Date**  
Adjust the date / time as required using the OK button to toggle through the fields and use the up & down buttons to set the values.  
Press MENU to exit and return to the Setup Menu.
- 3** **Language**  
Select your preferred language

**Options:** English, Danish, German, Spanish, French, Italian, Dutch, Norwegian, Finnish, Swedish  
**Default:** Follows your First Time Use selection.
- 4** **Screen Saver**  
Turn on the screen saver function to shut down the screen after 30 seconds of inactivity. Press any button to reactivate the screen.

**Options:** On and Off  
**Default:** Off

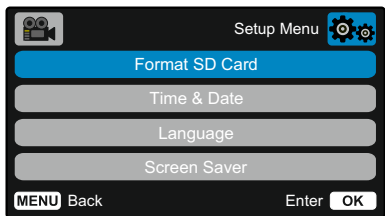

- 5** **Device Sounds**  
Turn On/Off the beep that sounds when a button is pressed. Start up sound is NOT muted.

**Options:** On and Off  
**Default:** On
- 6** **Auto Power Off**  
Adjust the timing of the Auto Power Off function, this can be used to continue recording in event of loss of power within in the vehicle.

**Options:** 10 seconds, 1 minute, 2 minutes  
**Default:** 10 seconds
- 7** **Number / License Plate**  
Enter the registration number for your vehicle, this will then be shown on the recorded video files. Use the OK button to toggle through the fields and use the up & down buttons to set values.
- 8** **Parking Mode**  
When Parking Mode has been turned on, the Dash Cam enters standby mode when the 12Vdc supply has been turned OFF (typically removing your ignition key).

The Dash Cam will also enter standby mode if no physical movement is detected for 5 minutes.

Should physical movement of the vehicle be detected, the Dash Cam will power on and start recording a 30 seconds protected video. If no further physical movement is detected then the Dash Cam will return to standby mode, if physical movement is detected subsequently, then the camera will continue to record normally, i.e. driving once more.

**Options:** On and Off  
**Default:** Off

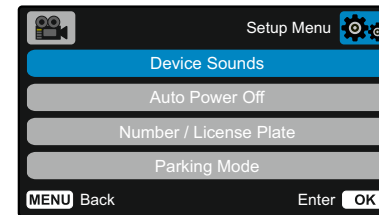

## Setup Menu Options (cont.)

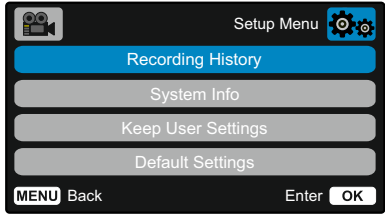

### 9 Recording History

In some territories, there are laws prohibiting the amount of footage your Dash Cam can store. The default is 'Maximum', where your Dash Cam records and stores videos without restriction. However, if 'Minimum' is selected, your Dash Cam will be limited to storing only 4 files at a time. When a new file is recorded it will overwrite the oldest file, keeping the number of files stored at a maximum of 4.

**Note:** When you select 'Minimum', you will be asked to confirm that all files will be deleted. Back up any files you wish to keep (including protected files) before switching to 'Minimum' storage mode.

While recording, protected files do not contribute towards the 4 video limit. These videos are assumed to be of interest as they are protected either by abnormal G Sensor activity or by a manual activation of the protect function.

**Options:** Maximum and Minimum  
**Default:** Maximum

### 10 System Info

Information such as Dash Cam model, Battery Status, Firmware version, and SD card data can be found here.

This information covers multiple screens (pages), press OK to scroll through as required.

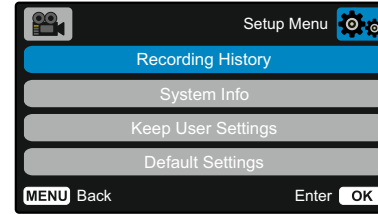

### 11 Keep User Settings

Turn this On in order to keep your preferred individual user settings during the Dash Cam update process.

Select Off in order to clear all user settings and return them to defaults during the Dash Cam update process.

### 12 Options: On and Off Default Setting: Off

#### Default Settings

Resets your Dash Cam to the default settings.

## Video Mode

The key below explains the various information displayed on the screen when your Dash Cam is in Video mode, some icons will only be displayed once the relevant function has been selected within the Video menu, as described below.

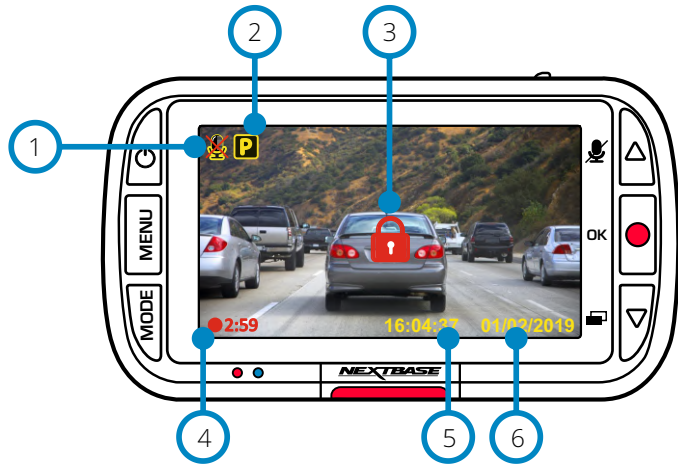

- 1 **Audio Recording ON**  
Can be switched OFF in the Dash Cam Setup Menu.
- 2 **Parking Mode ON**  
Can be switched OFF in the Dash Cam Setup Menu.
- 3 **File is protected**  
This will appear either when the 'protect' button is manually pushed, or when the G Sensor is triggered.
- 4 **Recording Duration**  
Up to 3 minutes. Length can be changed in the Dash Cam Setup Menu. .
- 5 **Time Display**  
Can be manually changed in the Dash Cam Setup Menu.
- 6 **Date Display**  
Can be manually changed in the Dash Cam Setup Menu. .

## Photo Mode

The key below explains the various information displayed on the screen when your Dash Cam is in Photo mode.

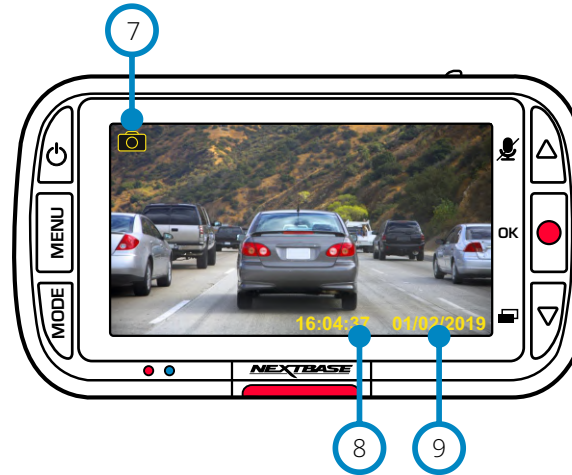

- 7 **Photo Mode**  
Press 'Mode' Button to toggle between Video, Photo, and Playback.
- 8 **Time Display**  
Can be manually changed in the Dash Cam Setup Menu.
- 9 **Date Display**  
Can be manually changed in the Dash Cam Setup Menu.

## Playback Mode

The key below explains the various information displayed on the screen when your Dash Cam is in Playback mode.

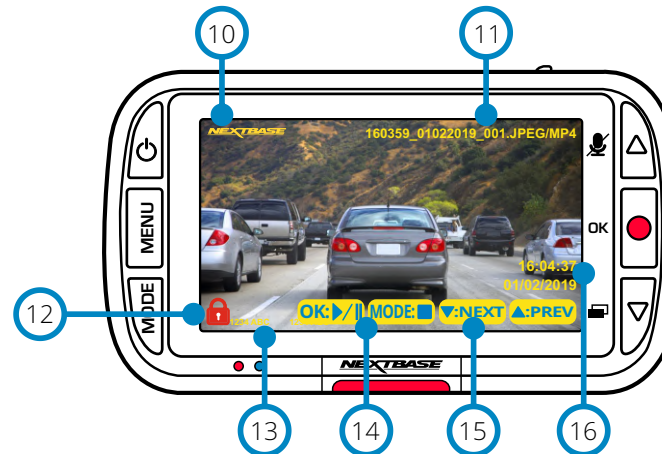

- 10 **Nextbase Logo Stamp**
- 11 **File Name**  
Photos are saved as JPEGs.  
Videos saved as .MP4.
- 12 **Protected File Icon**  
File can be protected/unprotected by pressing the Menu button while previewing files in playback mode.
- 13 **Info Stamps**  
License plate number, Dash Cam model, Time & Date. These can be turned ON/OFF in the menus.
- 14 **Playback options**  
Press Record to Play/Pause. Press Mode to Stop and return to file navigation.
- 15 **Navigation**  
Press the buttons on the right of the Dash Cam to scroll through the photos and videos stored on the SD card.
- 16 **Time/Date Display**  
Can be manually changed in Dash Cam Settings.

# Playback Mode Menus

If the Menu button is pressed while scrolling through your videos, you will open the Playback Menu, giving you the option to protect, *un*protect, or delete files. You can use the Menu button as a back button while in the menu system.

## How to Delete Files

Using the Up and Down arrows, select 'Delete Files'

On the next page, you will be asked if you want to ONLY delete the video/photo you are on, or if you would like to delete all (unprotected) files.

Once you have made your selection, you will be asked to confirm your choice.

When your choice is confirmed, you will be redirected back to Playback Mode to continue scrolling through your videos and photos.

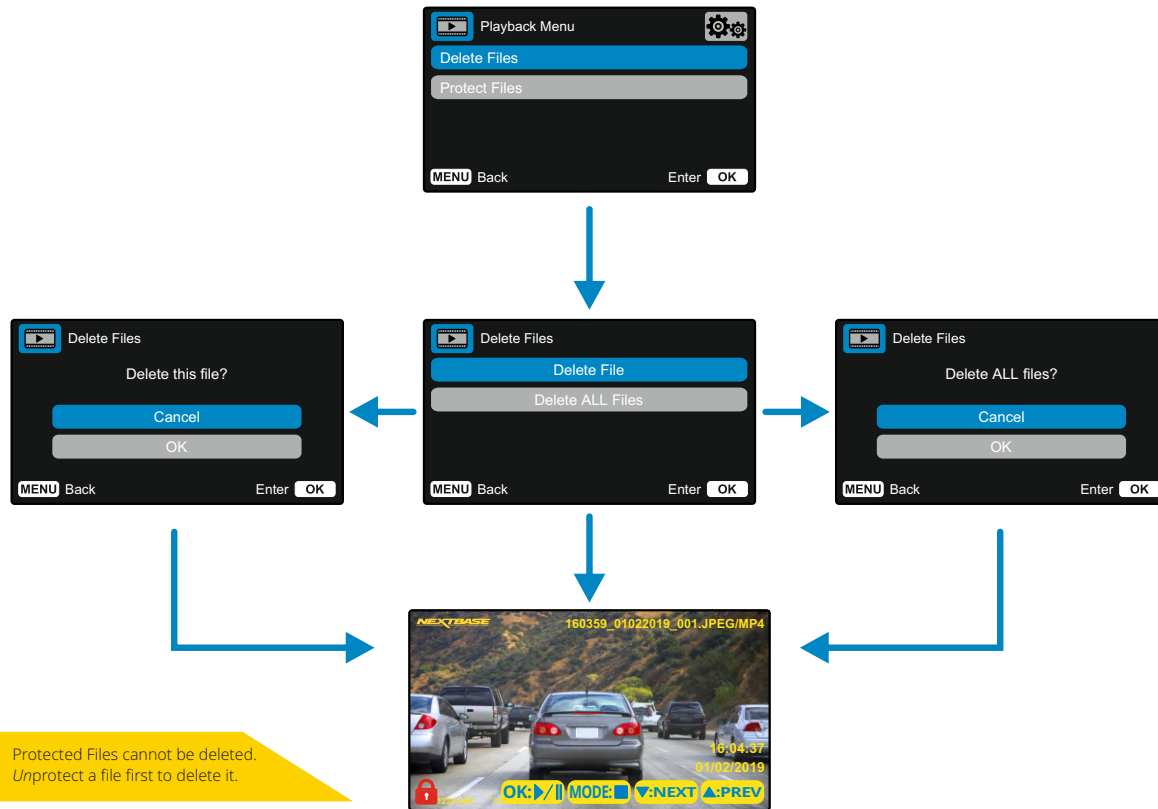

 Protected Files cannot be deleted. Unprotect a file first to delete it.

## How to Protect/Unprotect Files

Using the Up and Down arrows, select 'Protect Files'

On the next page, you will be asked if you want to Protect or Unprotect the file you are currently on.

You cannot protect a file that is already protected, and likewise cannot unprotect a file that is already unprotected. This action will have no effect and will divert back to the Playback display.

When you successfully protect or unprotect a file, a red padlock icon will be added or removed, respectively. This will be visible on the Playback display which you will be immediately diverted to, following your selection.

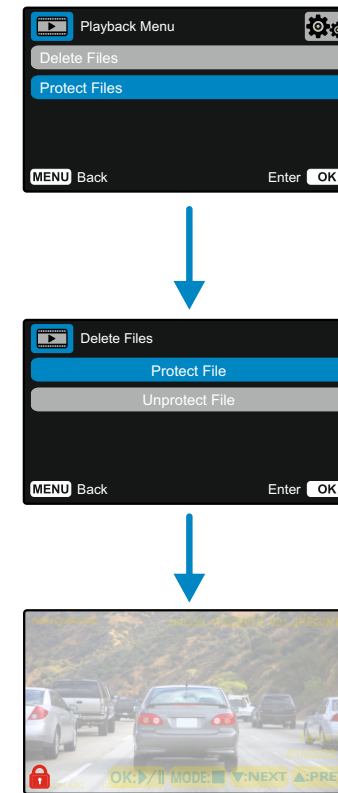

The red padlock icon will be added when you PROTECT a video/photo.

The red padlock icon will be removed when you UNPROTECT a video/photo.



# MyNextbase Player - Playback Software



View, edit, and share your footage on your computer with the new easy to use free PC/Mac software.

Connect your Dash Cam via USB (see 'PC Connection', page 28) or use an SD card reader (integrated or external), and drag and drop your files into the MyNextbase Player™ window. These will appear in the File List at the bottom right of the window. MyNextbase Player™ can be downloaded for free from the 'Support and Downloads' page at: [www.nextbase.com](http://www.nextbase.com).

Please note that not all features of MyNextbase Player are available when importing videos from the 222 Dash Cam. For example, the 222 does not record GPS data, so features such as the map and speedometer are not available. You are still able to view, edit, and share your videos.



## 1 Add Video

Add a video to the file list, ready for you to view, edit, and share. Clicking this will open your default file explorer; your Dash Cam/SD Card will appear as an external device. Once located, select the file(s) you wish to import.

## 2 Update Dash Cam

You can update your Dash Cam's firmware through MyNextbase Player™; please note that an internet connection is required to access the latest firmware version. You can ONLY update your 222 Dash Cam through MyNextbase Player™ if you are using a PC; this function will NOT work on Mac. For more information, see page 28 (Firmware Updates).

## 3 Snapshot

During video playback, Pause the video on the frame you would like to capture. You can move one frame at a time using the video controls beneath the playback timeline or the left/right arrow keys. Clicking 'Snapshot' will bring up a dialogue box with a 'Save Image' button. Click to save the image as a PNG in a destination of your choice

## 4 Edit Video

Within the video editing process you can join multiple videos together, trim the clips, add annotations and titles screens, and alter output settings. See the next page (page 26) for more details.

## 5 Share Video

Allows you to easily share your Dash Cam videos with insurance companies and social media. See page 27 for details on MyNextbase Cloud™.

## 6 Settings

Opens the settings tab for MyNextbase Player™. Options available include: language, speed units, software update options, map provider (Google maps or Open Street Maps), connection tips, error reports, and Nextbase™ special offers.

## 7 Help

Opens the Help menu for MyNextbase Connect™. Options available include: how to use, check for updates, Nextbase™ website, help & support, send diagnostics, register your Dash Cam, contact us, and about.

## 8 Playback Window

Displays Dash Cam videos playing in MyNextbase Connect™.

## 9 Zoom

Use to zoom in/out of the playback window. You can also use the scroll wheel on your mouse.

## 10 Video Timeline

Shows your playback position. Move the slider to move to a specific point in the video.

## 11 Video Playback Controls

Use to control playback of your videos. Includes colour adjustment, next/previous video, next/previous frame, stop, play, pause.

## 12 Volume Controls

Control the volume of the audio on the currently playing video.

## 13 File Management Bar

Add, remove, save, and filter videos in your file list.

## 14 File List

Displays your video library, ready for playback and editing. This list can be filtered in a number of ways, including by name, date, resolution, or whether the file is protected.

# MyNextbase Player - Editing Videos

To use MyNextbase Player™ to edit your recorded files, you need to ensure that the file you wish to edit is currently playing in the Playback Window. You can do this by double clicking the file as it appears in the File List window. When the file is playing, click on the 'Edit' button to begin the 6 step editing process.

## 1. Join Videos

The first step allows you to join multiple videos together. Your video will appear in the centre of the screen, with buttons on either side to add additional videos before or after the chosen video file. Clicking either of these buttons will open up the list of files in your library that can be added. Once added, these will appear next to your original video file. You can only join videos that are of the same resolution.

The order of the video files can be altered by clicking and dragging a video. To remove a video, hover over the chosen file and a 'Remove Video' option will appear. Click to remove this video.

Once you are happy with the video(s) selected, click on the continue button to move to step 2.

## 2. Trim Video

Trimming the video allows you to shorten your selected clip to only include the incident or event that you are interested in. To the left of the Playback Timeline is a green marker, indicating the beginning of your video. To the right of the Playback Timeline is a red marker, indicating the end of your video. These can be dragged to a point on the Timeline of your choosing; when exporting, MyNextbase Player™ will create a single video file from the footage located between the markers. The white marker indicates your current playback position.

## 3. Annotate Video

During the video there may be an object or incident that you wish to highlight, annotating your video will allow you to do this. When you annotate a frame, your video will pause at the specified frame and display any annotations that you have added. The video will resume after 4 seconds.

To begin adding annotations, find the frame you wish to annotate (using the white marker, and left/right arrows to scroll through frames), and click on the 'Add Annotation' button to open the annotation screen. Along the top of the annotation screen you will see the annotation tools - Draw, Circle, Square, Rectangle, and Text. Clicking any of these options will add an editable annotation to that frame. This shape/text can be moved, resized, and rotated using the handles on the sides and corners of the selected annotation.

When you have finished your annotation, click 'Save and Close' to return to the Add Annotation screen, where more annotations can be added. When you have finished adding annotations, press 'Continue' to proceed.

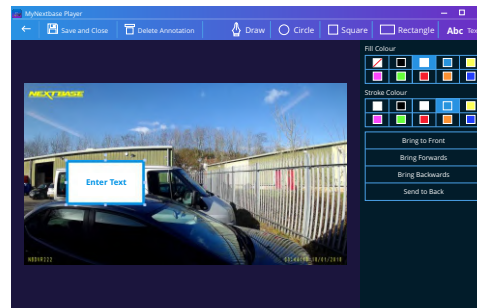

Annotation window

## 4. Add Title Screen

Add a title screen to your video. The title will be displayed for 4 seconds at the start of your video. To add a title, click inside the white rectangle and type the desired title. Press 'Continue' to proceed.

## 5. Output Settings

The final step in the editing process allows you to specify the quality of your video file and the data included.

The Video Resolution determines the quality of the video footage; by default the Video Resolution will be set to output at the same quality as the original files. Lowering the Video Resolution will produce lower resolution files but will also reduce the size of the file and lower the time it takes to produce the file. You can also remove the audio from the video by ticking the corresponding box. Once the data has been removed it cannot be added back into the edited video. This will not affect the original file.

Lastly, you can specify the name of the file being created and the location that you would like it saved. When you have chosen your output settings click on the 'Confirm' button and MyNextbase Player™ will begin processing your video.

## 6. Process Video

During step 6, MyNextbase Player™ will process your video clip(s) and edits, and produce a single file in the location specified. This can take some time and will depend on the number and length of video files being joined and video resolution. Once the video has been processed, it will be added to your MyNextbase Player™ file list.

## Video Sharing

Videos can be shared to social media and insurers through the 'Share Video' button. When a destination is selected (i.e Facebook), the target web page will open in your default browser. You will then be asked to sign into your account, and once you are logged in, the browser will close and a pop up will show your upload's progress. When the file is finished uploading you will see an option to view your uploaded file. Videos can also be upload to the Nextbase™ server; you will be e-mailed a secure link to view or download your video. This link can be sent to your insurer, without the need to transfer a large video file. Videos will be automatically deleted 30 days after upload.

Some functions, such as GPS data, are available only on select models.



# MyNextbase Cloud™



MyNextbase Cloud™ is our free online video sharing service where you can safely and securely store your Dash Cam files. Upload your file to the Nextbase™ Server using the 'Share Video' function on either MyNextbase Player™, or the MyNextbase Connect™ app. Please note that upload times are dependent on video file size. Once your video has finished uploading you will be given a secure link to watch your video online and/or download it to your computer/device. This link can be shared with others (including your insurer) to view/download the video. Videos will be automatically deleted 30 days after they are uploaded.

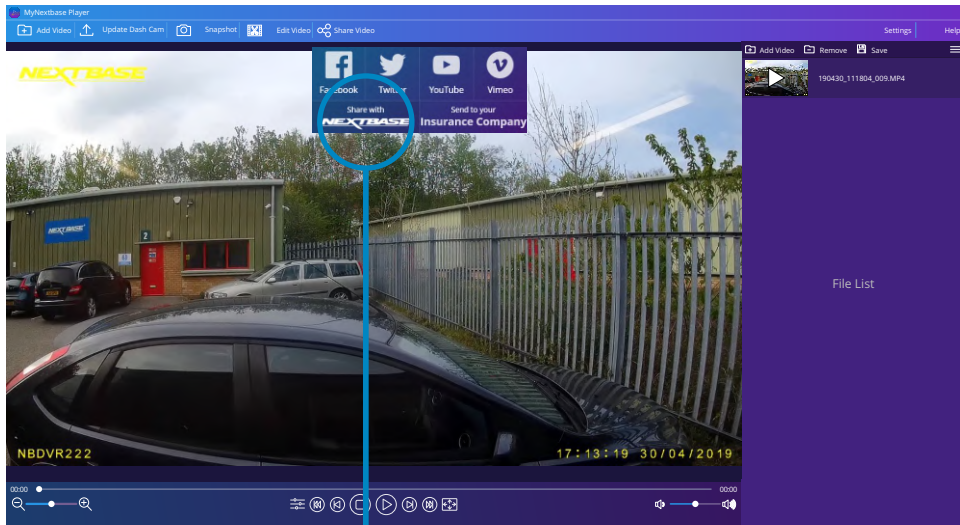

Selecting 'Share Video' will allow you to choose where to upload your video to. Select 'Share with Nextbase™' to upload your video to MyNextbase Cloud™, and bring up the upload window.

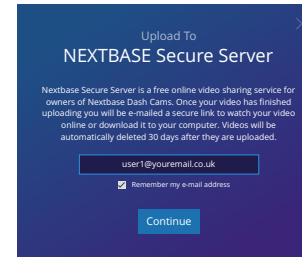

The upload window will guide you through the upload process; next, you will be prompted to enter your e-mail.

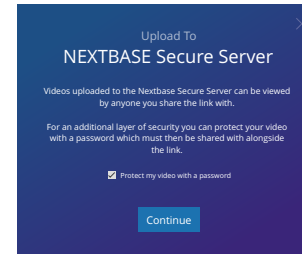

You will have the option to protect your video with a password.

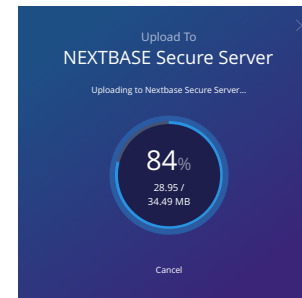

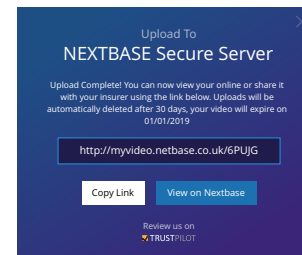

Once the setup of the video has been decided, the upload will begin. Upload times are dependent on file size and internet speed.

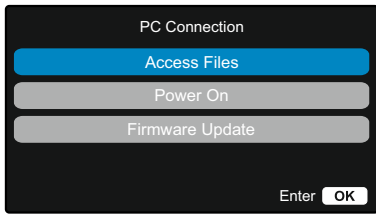

When the upload has completed, you will be given a unique web address that will link to your video hosted on the Nextbase™ server. This link can be shared with others (including your insurer) so that they too can view/download the video. When you first view the video online you may see this message: *"This video was uploaded very recently, it may take up to half an hour to generate the online preview however your video can be downloaded immediately."* This is normal and the preview will become available within half an hour.

## PC Connection



Use the supplied USB cable to connect the Dash Cam directly to your PC via the  socket on top of the Dash Cam; do NOT connect the USB cable to the Powered Mount.

Once connected the Dash Cam will turn on with two options available; 'Access Files' and 'Power On', as described below.

Use the UP and DOWN buttons to select required function and press OK to confirm selection.

### Access Files (Windows)

When this option is selected, the Dash Cam will function as a card reader for your PC. An extra drive will appear, e.g. NEXTBASE (D:) and you will be able to view / manage the stored files upon the MicroSD card within the Dash Cam. You will be able to view your files using your system's default media player.

The Dash Cam is a 'read-only' device, therefore uploading files to the SD card when in Mass Storage mode is not possible. If you wish to add files to the SD card you can do this using a MicroSDcard reader.

### Access Files (Mac)

When this option is selected, the Dash Cam will function as a card reader for your Mac. The 'Nextbase' external USB disk icon will appear on your Mac and you will be able to view and/or manage stored files. You will be able to view your files using your system's default media player.

The Dash Cam is a 'read-only' device, therefore uploading files to the SD card when in Mass Storage mode is not possible. If you wish to add files to the SD card you can do this using a MicroSd card reader.

### Power On (Windows & Mac)

When this option is selected, the Dash Cam will power on with all functions available. This includes charging of the internal battery; a full charge will take approximately 2 hours.

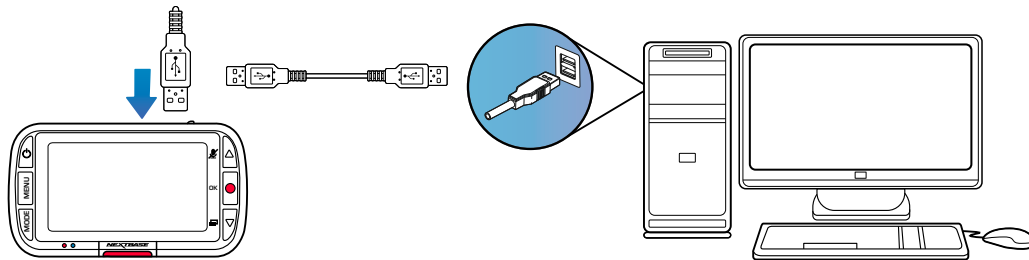

## Firmware Update Information

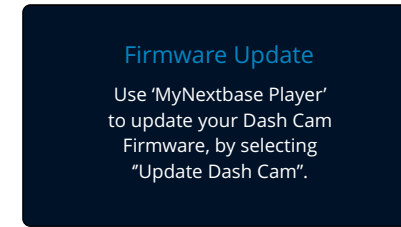

Firmware controls the basic functioning of the Dash Cam. If your Dash Cam is not functioning correctly, you may need to update the firmware.

Firmware updates may also be released to fix bugs, and improve the general functionality of the Dash Cam. In short, it's important to keep the firmware on your Dash Cam up to date so it can operate to its full capacity. We recommend you regularly check for updates to get the most from your new Dash Cam

### How to Check your Dash Cam's current Firmware Version

Within the Setup Menu, on page 3, select 'System Info'. Here you will find information relating to your Dash Cam, including what firmware version is currently active (i.e R05.3).

### Ways to Update Firmware on your Dash Cam

Connect your Dash Cam's SD Card to PC or Mac using a card reader. This will open a file explorer drive, (e.g Removable Disk (E:)) and show the contents of your SD Card. Go to the 'Support & Downloads' page on nextbase.com and download the newest firmware version (i.e R05.4); this will download as .bin file. Drag and drop the .bin file to the SD Card explorer.

Eject the SD card and insert it back into your Dash Cam. When you connect the power cable your Dash Cam will turn on, and will automatically begin updating. While updating, both the Nextbase™ logo beneath the screen and the red LED to the left of the screen will start flashing.



Your Dash Cam will show the following message: "Firmware Updating... Update takes approx 2 mins. Do not disconnect power!"

Once the update has been completed, the logo and LED will stop flashing, and your Dash Cam will automatically restart.

If you have a PC, You can also update your Dash cam using the 'Update Dash Cam' function on MyNextbase Player™. This function will NOT work on a Mac. Connect your Dash Cam to PC via USB, select 'Firmware Update' and open up MyNextbase Player™ (available to download for free from nextbase.com). Select 'Update Dash Cam'. A pop-up will appear on your PC describing your current firmware, and the latest version available. When you select update, your Dash Cam will automatically begin updating. While the Dash Cam is updating, both the Nextbase™ Logo below the screen, and the red LED will flash. Please note that an internet connection is required for the Dash Cam to be updated.

**Notes:** If 'Keep User Settings' is turned ON in the Setup Menu, your Dash Cam will boot up normally, straight into video live view mode, ready to use. If 'Keep User Settings' is turned OFF, after the update is complete, the Dash Cam will boot up into the First Time Use menu, which must be completed before the Dash Cam can be used.

Be sure to externally back up any files you want to keep before updating the firmware.

## Nextbase™ SD Cards

For best results, we recommend using our Nextbase™ branded SD cards with your Dash Cam, available to purchase online from [nextbase.com](http://nextbase.com), or your nearest retailer.

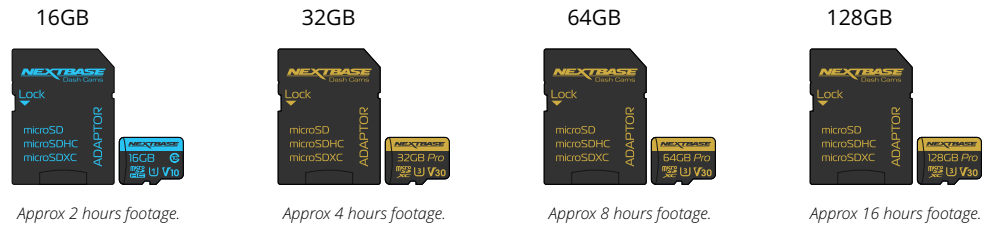

We recommend formatting your SD Card every 2 weeks to ensure that there is enough space to record and store new footage. When formatting, protected files WILL be deleted. If you wish to keep these protected files, you must back them up externally, most commonly by saving files to a desktop computer, or another secure storage point. To clear your SD card, go to the 'Format SD Card' function in your Dash Cam's Setup settings Menu and follow the instructions on screen.

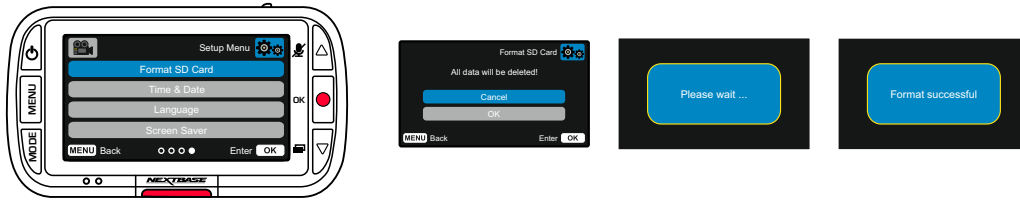

### Which SD Card should I use in a Dash Cam ?

Nextbase have designed an SD card specifically to fulfill the needs of our Dash Cams. We work directly with the factory to ensure consistency of the SD card quality. Nextbase have spent years testing, trialling, and developing SD cards to optimise their performance with our Dash Cams.

Due to the differences in technology an SD card that works with a mobile phone or computer won't necessarily work well with a Dash Cam. The main differences and selling points between all SD cards are the storage size (16GB, 32GB, 42GB, etc.) and the READ speed. READ speed isn't too important when it comes to Dash Cams, as a Dash Cam WRITES data to the SD card when recording. The ability to maintain a high WRITE speed consistently is what Nextbase SD cards are designed to do better than any other SD card. Any drop/fluctuation in WRITE speed within the SD card causes the Dash Cam footage to buffer, and in some cases will stop the recording entirely. Years of research and design allows our SD card controller and Firmware on the SD card to achieve the requirements of our Dash Cams, where other SD cards cannot.

A large requirement our Dash Cams place on the SD card is the ability to re-WRITE over the oldest footage when the SD memory becomes full. This means the Dash Cam is always Loop Recording - when the Dash Cam is on it is always recording. From our experience most non-Nextbase SD cards struggle to do this as effectively as our SD cards, this has caused footage to be missing and footage to fail to record in the first place.

### SD Card Q&A

#### Q) "Why should I buy a Nextbase branded SD card? Can't I just use any card?"

A) Our cameras have different requirements to other recording devices; this is because they need to keep recording when the SD card is full whilst overwriting the oldest unprotected files at the same time.

#### Q) "Why are Nextbase SD cards more expensive than other brands SD cards?"

A) Years of research and development have led to the creation of an SD card that has superior capabilities to ensure it works with a Dash Cam, where other SD cards don't have such capabilities. Dash Cams have greater technological requirements from an SD card than a mobile phone or computer, for example, thus the larger price tag.

#### Q) "Do non-Nextbase SD cards work at all?"

A) A card that is not made for this purpose may appear to work perfectly in the beginning, although failure tends to happen after prolonged use, this could be days, weeks, or months. In a worst-case scenario, you may only discover recording failure after your SD card fails to record a serious incident, therefore using a suitable card is imperative.

#### Q) I have a rear camera module as well as the Dash Cam, which SD card do I need?

A) If you are using a Rear Camera Module and a Dash Cam you need to ensure that a U3 SD card is used inside the camera. It is important to note that our 32GB U3 microSD card will record approximately 4 hours of HD footage before the Dash Cam overwrites the oldest recordings, or 2 hours if using a Rear Camera Module. The 64GB U3 microSD card will record 8 hours of HD footage, or 4 hours if using a Rear Camera Module. The largest SD card you can use is our Nextbase 128GB U3 microSD card can record 16 hours of HD footage, or 8 hours if using a Rear Camera Module.

#### Q) "What errors may I encounter using a faulty or incompatible SD card?"

A) You may experience any of the following:

- SD error messages
- Recording failure
- Automatic recording failure
- Frozen screen
- Gaps between recordings
- Corrupted or unplayable files
- Failure to startup and shutdown
- Inoperable buttons

If you experience any of the faults listed above, we strongly recommend that you replace your SD card with a Nextbase one. All our dashcams are tested using Nextbase branded SD cards, therefore we cannot attest to the compatibility of other manufactures products. For best results we always recommend using Nextbase branded cards.

Best practice is still to Format the SD card occasionally - for a heavy user this would be every two weeks, for a light user this would be once a month.



## Frequently Asked Questions

Problem	Solution
Video Image is blurred.	Remove the protective lens cover, clean the lens, make sure the windshield is clean and clear of grease, dirt, and debris. Ensure that the Polarising Filter has been set properly; see the Accessories Manual (available from <a href="http://www.nextbase.com">www.nextbase.com</a> ) for instructions on how to set up the Lens.
I cannot insert the MicroSD card.	MicroSD cards are very small and require delicate use. Align the card with the diagram shown upon the Dash Cam and insert the card until you feel a slight spring resistance. You now need to push the card, using your finger nail until you hear and feel a small click. Release pressure and the card will stay retained within the Dash Cam. If you are having difficulty, use the edge of a small coin.
I cannot remove the MicroSD card.	With the card installed, using your fingernail, you now need to push the card further inwards slightly, until you hear and feel a small click. If you are having difficulty, use the edge of a small coin. Release pressure and the MicroSD card will spring out far enough for you to take a hold of it.
Video Files cannot be played on my computer.	The video files from the Dash Cam are in .MP4 format and may not be compatible with your PC if suitable playback software is not installed.
Video File playback is jumpy.	Remove the SD card and format to remove non-contiguous files. For best recording use a branded class 10 type (48MB/s) or UHS type 1 micro SD card of 8 to 128GB recommended size. PC may not be sufficient for the playback task, try a different PC. Copy the recorded video files onto the PC / Mac for playback directly rather than use the Dash Cam as a card reader, as the USB system on your PC may be too slow for HD video playback.
The sound is not synchronised with video during playback.	The Codecs upon your PC may not be compatible or the latest standard. Download the latest Codecs from: <a href="http://www.nextbase.com">www.nextbase.com</a> .
Video has no sound.	Ensure that 'Record Audio' setting is turned ON within the Video Menu.
Photograph is blurred.	Hold the camera still whilst taking the photo. Be aware that the photo is taken approximately 1 second after the shutter sound is heard.
I can only record a few minutes of video on my MicroSD card.	Change the recording size (Video Length function) to a smaller size. Increase the size of the MicroSD card. Max 128GB. In the Setup Menu, ensure that Recording History is set to Maximum. Minimum limits the total number of recordings on your Dash Cam to 4.
Access Files does not work.	The Access Files function will work on both Windows and Mac. Restart the PC, as this may be required for the necessary driver to be loaded correctly. Disconnect and reconnect the Dash Cam. Please bear in mind you cannot transfer files to the Dash Cam in 'Access Files'. Files can be transferred to the SD Card using an SD Card reader.
I cannot save files to the memory card when the Dash Cam is connected to my computer under 'Access Files'.	Correct, the Dash Cam is a 'read-only' device. It is not recommended to save files from other sources to the same memory that you will use for recording within the Dash Cam, as these may have a negative effect on the performance of the Dash Cam.
The sucker will not stay in place upon my windshield.	Ensure that the protective cover (plastic film) has been removed from the suction pad. Moisten the sucker slightly before affixing upon the windshield. Ensure that the locking lever is fully closed. Make sure that the glass is smooth and clean. Do not stick to glass that has any non-smooth effect or paint whatsoever. Affix to the glass firmly and then close the locking lever fully.
My Dash Cam shuts down by itself after a while.	Either the battery has gone flat, there is no power to the Dash Cam and the Auto Power Off period has been triggered or Parking Mode has been turned on and no vehicle movement has been detected for 5 minutes.
No power to my Dash Cam but it works upon my computer.	The cigarette power cable is not working. Inspect the fuse in the Car Power Cable plug. Replacement fuse = 2A 32mm type. If the fuse is found to be blown, inspect the power cable for damage which may have caused the fuse to blow.
I can't delete files on my SD card within the Dash Cam.	Check to see if these files are 'protected'. If so please follow instructions to 'un-protect'.

Problem	Solution
The screen blanks after a few minutes upon my Dash Cam.	The screen saver is set to ON. Change settings to OFF if required. Default setting is OFF.
I get the message: "Cluster size wrong. Please format SD card" on screen.	The SD card has been formatted in another device and the Cluster size is not compatible. Use the Setup Menu to format the SD card from within the SD card.
The battery will not charge.	Ensure the Dash Cam is connected to a reliable power source and that the supplied Car Power Cable is being used, with the blue LED lit.
The battery only lasts 30 seconds.	The battery will only receive charge when the Dash Cam is connected to a power source, Charging takes approximately 2 hours and a full charge is indicated when the blue LED on the Dash Cam goes out. To charge, take the Dash Cam indoors and charge it for 2 hours; once fully charged, check to see if the problem persists. If it persists, the car power supply may be causing the issue.
The battery only lasts 10 - 15 minutes.	This is normal, the battery design allows the 'Auto Power Off' feature to function in event of power loss within the vehicle. It is not intended as an alternative power source to replace the supplied car adaptor.
I get the message "SD Card Error" on screen.	The SD card has become unusable by the Dash Cam. Back up useful files to your PC and then Format your SD card from within the Dash Cam setup menu.
I get the message "Card Full" on screen.	The SD card has become full as there are too many protected files which cannot be deleted to allow for further recording to take place. Transfer useful files to your PC and delete unnecessary files, or Format the SD card from within the Dash Cam setup menu.
I have turned on 'Parking Mode' and now can't stop the recording.	The Dash Cam will start a recording whenever motion is detected. To turn off Parking Mode firstly shutdown the Dash Cam and remove the SD card, this will avoid recording being activated accidentally. Switch the Dash Cam On and within the Setup Menu, turn off the 'Parking Mode'.
When I press the Menu button nothing happens.	This is normal during recording. Stop the recording before pressing the MENU button. If recording re-starts before you can press MENU, then see the Parking Mode section above.
Downloading files from <a href="http://www.nextbase.com">www.nextbase.com</a> using Google Chrome results in a Malicious Software message.	This is not a cause for concern, as this message will appear whenever new software is downloaded from the internet. Simply go to the settings within Google Chrome and turn off the malicious software protection temporarily to download and install the playback software. Reinstate previous Google Chrome settings afterwards.
There's no PC Connection screen when connected to my computer.	Try multiple USB ports and an alternative mini USB cable (if possible). Please ensure it is inserted into the USB port on the Dash Cam and not into the mount.
My Camera feels warm when it is operating.	It is normal for the camera to feel warm during typical use, especially when it's recording high definition video or communicating via Wi-Fi.
Unresolved Issues	Reset the Dash Cam to the default settings within the Setup Menu and try again. Should the problem persist call the UK helpline (02920) 866429 or call your local support centre, found at <a href="http://www.nextbase.com">www.nextbase.com</a> Alternatively email: <a href="mailto:support@nextbase.com">support@nextbase.com</a>

## CE Mark Information (Conformité Européenne)

The CE (Conformité Européenne) mark is a symbol (below) printed on products to indicate its conformity with health, safety, and environmental protection standards for products sold within Europe. It is used on many products across many industries (for example, SD cards) as a mark of compliance with European standards.



In recent years, many variations of this mark have appeared in the market. While similar, the mark above is the *only* variant that is associated with, and declares compliance with European standards. Other marks, like the ones below, do not guarantee that the product it is attached to or is compliant with European standards for sale in the European Economic Area (EEA).



The main difference between a legitimate CE mark and a misused CE mark is the spacing of the letters. The letters, C and E, tend to be formed identically, however the spacing between them is what separates the real from the false. The images below show how the letters should be spaced. There will never be additional markings such as a border or circle used on a legitimate CE Mark.



CE Mark



False CE Mark  
(too close)



False CE Mark  
(too far)

As products without the correct CE marking are not guaranteed to comply with European Health and Safety standards, those products are potentially less reliable and could pose a safety risk. Be aware of the CE marking when purchasing electrical products. The descriptions above of false CE markings are not comprehensive; be aware that new variations may appear on the market.

## Software License Agreement

By using the device, you agree to be bound by the terms and conditions of the following software license agreement.

Nextbase™ grants to you for the period for which you possess the relevant device a non-exclusive, non-transferrable (save in circumstances where you sell or transfer the relevant device to another person – please see below for more details) a limited license to use the software embedded in this device (the “Software”) in binary executable form in the normal operation of the product together with any documentation and material (whether printed or on-line) made available by Nextbase™ in respect of the Software (the “Documentation”). Title, ownership rights, and intellectual property rights in and to the Software and the Documentation remain in Nextbase™ and/or its third-party providers.

You acknowledge that the Software and the documentation is the property of Nextbase™ and/or its third-party providers and is protected throughout the world by intellectual property rights laws and treaties, including the United States of America and international copyright treaties.

You further acknowledge that the structure, organization, and code of the Software, for which source code is not provided, are valuable trade secrets of Nextbase™ and/or its third-party providers and that the Software in source code form remains a valuable trade secret of Nextbase™ and/or its third-party providers. You agree not to decompile, disassemble, modify, reverse assemble, reverse engineer, or reduce to human readable form the Software or any part thereof or create any derivative works based on the Software or the Documentation.

You agree not to copy, rent, lease, sub-license, loan, translate, merge, adapt, vary, alter or modify, the whole or any part of the Software or Documentation nor permit the Software or any part of it to be combined with, or become incorporated in, any other programs

You agree not to export or re-export the Software or Documentation to any country in violation of the export control laws of the United States of America or the export control laws of any other applicable country.

If you use MyNextbase Connect™ or MyNextbase Player™, you must comply with the applicable terms of use and acceptable use policies, which can be found at [www.Nextbase.com](http://www.Nextbase.com).



## Warranty

### Limited Warranty

This limited warranty gives you specific legal rights, and you may have other legal rights, which vary from state to state (or by country or province). Nextbase™ does not exclude, limit or suspend other legal rights you may have under the laws of your state (or country or province). For a full understanding of your rights you should consult the laws of your state, country or province.

Nextbase™ Liability extends to the cost of the Dash Cam alone. Any recordings which have not taken place or recoverable from the SD card for whatever reason are not covered by the product warranty. No liability for costs incurred due to corrupt, missing, erased video recordings will be accepted. No claims for additional costs outside the cost of the Dash Cam itself will be accepted.

Nextbase™ products are warranted to be free from defects in materials or workmanship for one year from the date of purchase, with batteries warranted to be free from defects in materials or workmanship for six months from the date of purchase. Within this period, Nextbase™ will, at its sole option, repair or replace any components that fail in normal use. Such repairs or replacement will be made at no charge to the customer for parts or labour, provided that the customer shall be responsible for any transportation cost. This Limited Warranty does not apply to: (i) cosmetic damage, such as scratches, nicks and dents; (ii) consumable parts, such as batteries, unless product damage has occurred due to a defect in materials or workmanship; (iii) damage caused by accident, abuse, misuse, water, flood, fire, or other acts of nature or external causes; (iv) damage caused by service performed by anyone who is not an authorised service provider of Nextbase™; (v) damage to a product that has been modified or altered without the written permission of Nextbase™, or (vi) damage to a product that has been connected to power and/or data cables that are not supplied by Nextbase™, or (vii) damage to a product that has been connected to 12Vdc directly, having cut off the Cigarette Lighter plug which contains the 12/24Vdc to 5Vdc adaptor. In addition, Nextbase™ reserves the right to refuse warranty claims against products or services that are obtained and/or used in contravention of the laws of any country.

To the maximum extent permitted by applicable law, the warranties and remedies contained in this limited warranty are exclusive and in lieu of, and Nextbase™ expressly disclaims, all other warranties and remedies, whether express, implied, statutory, or otherwise, including without limitation any implied warranty of merchantability or fitness for a particular purpose, statutory remedy or otherwise. This limited warranty gives you specific legal rights, and you may have other legal rights, which vary from state to state and from country to country. If implied warranties cannot be disclaimed under the laws of your state or country, then such warranties are limited in duration to the duration of this limited warranty. Some states (and countries and provinces) do not allow limitations on how long an implied warranty lasts, so the above limitation may not apply to you.

In no event shall Nextbase™ be liable in a claim for breach of warranty for any incidental, special, indirect or consequential damages, whether resulting from the use, misuse or inability to use this product or from defects in the product. Some states (and countries and provinces) do not allow the exclusion of incidental or consequential damages, so the above limitations may not apply to you.

If during the warranty period you submit a claim for warranty service in accordance with this Limited Warranty, then Nextbase™ will, at its option: (i) repair the device using new parts or previously used parts that satisfy Nextbase™'s quality standards, (ii) replace the device with a new device or a refurbished device that meets Nextbase™'s quality standards. Such remedy shall be your sole and

## Warranty (cont.)

exclusive remedy for any breach of warranty. Repaired or replaced devices have a 30 day warranty. If the unit sent in is still under its original warranty, then the new warranty is 30 days or to the end of the original 1 year warranty, whichever is longer.

Before seeking warranty service, please access and review the online help resources available on [www.nextbase.com](http://www.nextbase.com). If your device is still not functioning properly after making use of these resources, contact a Nextbase™ Authorised service facility in the original country of purchase or follow the instructions on support at [www.nextbase.com](http://www.nextbase.com) to obtain warranty service.

If you seek warranty service outside of the original country of purchase, Nextbase™ cannot guarantee that the parts and products needed to repair or replace your product will be available due to differences in product offerings and applicable standards, laws and regulations. In that case, Nextbase™ may, in its sole discretion and subject to applicable laws, repair or replace your product with comparable Nextbase™ products and parts, or require you to ship your product to a Nextbase™ Authorised service facility in the country of original purchase or to a Nextbase™ Authorised service facility in another country that can service your product, in which case you will be responsible for complying with all applicable import and export laws and regulations and for paying all custom duties, V.A.T., shipping fees and other associated taxes and charges. In some cases, Nextbase™ and its dealers may be unable to service your product in a country outside of the original country of purchase or return a repaired or replaced product to you in that country due to applicable standards, laws or regulations in that country.

## Online Auction Purchases of Non-New Goods

Products purchased through online auctions are not eligible for Nextbase™ warranty coverage. Online auction confirmations are not accepted for warranty verification. To obtain warranty service, an original or copy of the sales receipt from the original retailer is required. Nextbase™ will not replace missing components from any package purchased through an online auction.

## International Purchases

A separate warranty may be provided by international distributors for devices purchased outside the United Kingdom depending on the country. If applicable, this warranty is provided by the local in-country distributor and this distributor provides local service for your device. Distributor warranties are only valid in the area of intended distribution.



### Dash Cams

#### Eyes on the Road

Nextbase™ offers a wide range of Dash Cams to best suit your driving needs.



122



222



322  
GW



422  
GW



522  
GW

### Rear View Cameras

#### Ready for the Drive

The new rear facing cameras offer views on the road behind as well as ahead, protecting you from all angles.



### Accessories

#### Ready for the Drive

Everything you might need for video storage, Dash Cam protection, and more.



For more details on our full range of Dash Cams and Accessories, download the Nextbase™ Accessories Manual, available from [www.nextbase.com](http://www.nextbase.com)

### Nextbase™ Services and Software



MyNextbase.com Cloud™

Access your footage anywhere in the world using the free online web portal (Internet connection required).



MyNextbase Connect™

The new Nextbase App to transfer, view, and edit footage on your smart-phone or tablet.



MyNextbase Player™

View, edit, and share your footage on your computer with the new easy to use free PC/Mac software.

### Dash Cam Services Compatibility

	MyNextbase Cloud™	MyNextbase Connect™	MyNextbase Player™
122	✓	✗	✗
222	✓	✗	✓
322 GW	✓	✓	✓
422 GW	✓	✓	✓
522 GW	✓	✓	✓

















122

222

322GW

422GW

522GW

	<b>Main Resolution</b>	720p @ 30fps	1080p @ 30fps	1080p @ 60fps	1440p @ 30 fps	1440p @ 30 fps
	<b>Screen</b>	2" LED HD IPS	2.5" LED HD IPS	2.5" LED HD IPS Touch	2.5" LED HD IPS Touch	3" LED HD IPS Touch
	<b>Viewing Angle</b>	120°	140°	140°	140°	140°
	<b>GPS</b>	No	No	10x GPS	10x GPS	10x GPS
	<b>Wi-Fi</b>	No	No	QuickLink Wi-Fi	QuickLink Wi-Fi	QuickLink Wi-Fi
	<b>Bluetooth</b>	No	No	4.2	4.2	4.2
	<b>Polarising Filter</b>	Compatible	Compatible	Compatible	Compatible	Yes
	<b>Alexa</b>	No	No	No	Alexa built-in	Alexa built-in
	<b>Parking Mode</b>	Intelligent	Intelligent	Intelligent	Intelligent	Intelligent
	<b>Nextbase™ Emergency Response</b>	No	No	Yes	Yes	Yes
	<b>Nextbase™ Module Cam Compatible</b> (Rear Cam, Rear Facing Cam)	No	No	Yes - Front 1080p Rear 720p	Yes - Front 1440p/1080p Rear 720p/1080p	Yes - Front 1440p/1080p Rear 720p/1080p
	<b>Nextbase Cloud™ Storage</b>	Yes	Yes	Yes	Yes	Yes
	<b>MyNextbase Player™</b>	No	Yes	Yes	Yes	Yes
	<b>MyNextbase Connect™</b>	No	No	Yes	Yes	Yes

# **NEXTBASE** Dash Cams



[www.nextbase.com](http://www.nextbase.com)

